

CONSTRUCTIONS DES THÉÂTRES
(SYSTÈME FRANÇAIS)

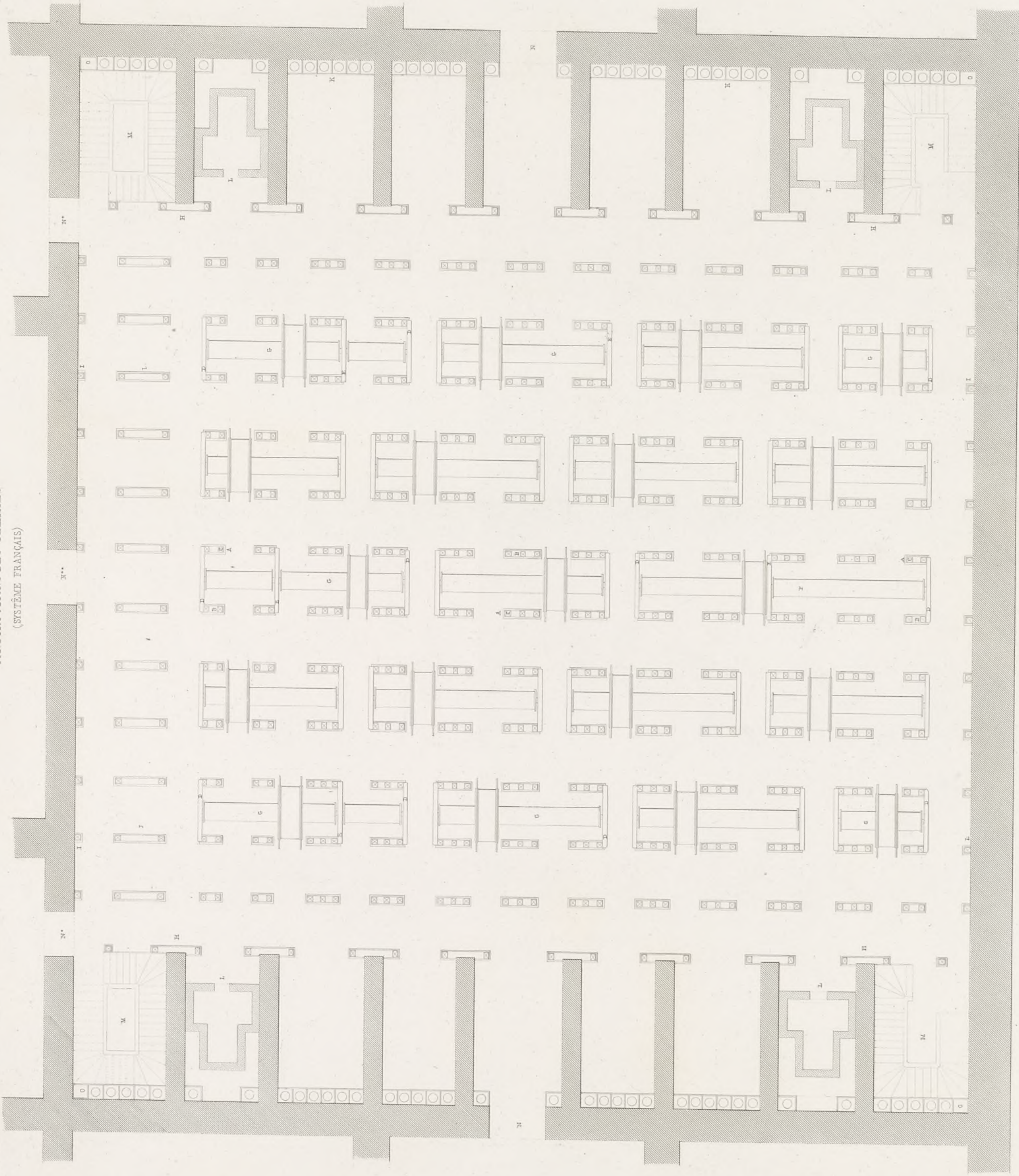

Dep^{te} L. Maréchal, 18

C. Coustaut del.



CONSTRUCTION DES THÉÂTRES
(SYSTÈME FRANÇAIS)

PL. 2

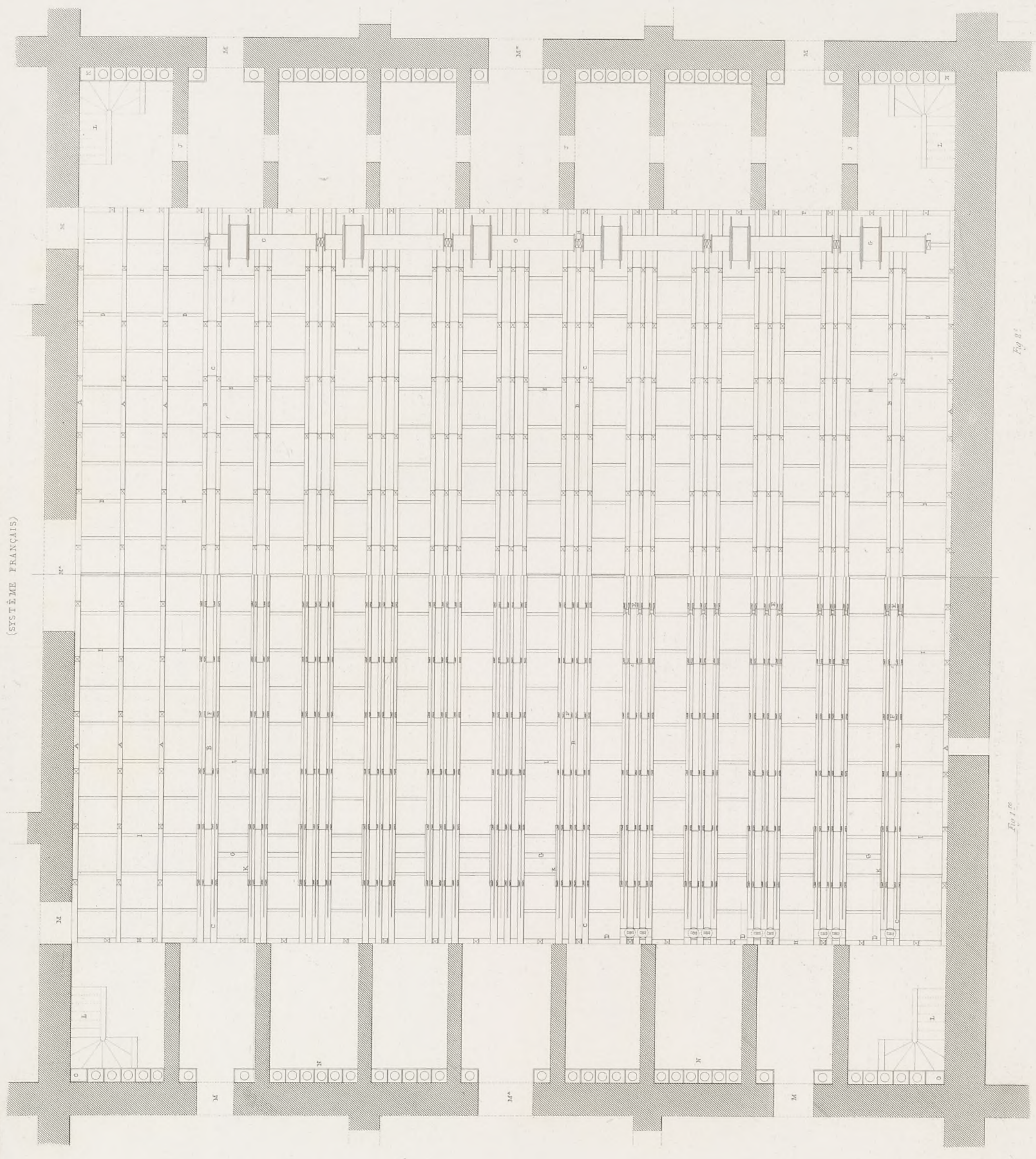

Fig. 81

Fig. 82



C. Coustard del.

Alfred Vialart del.

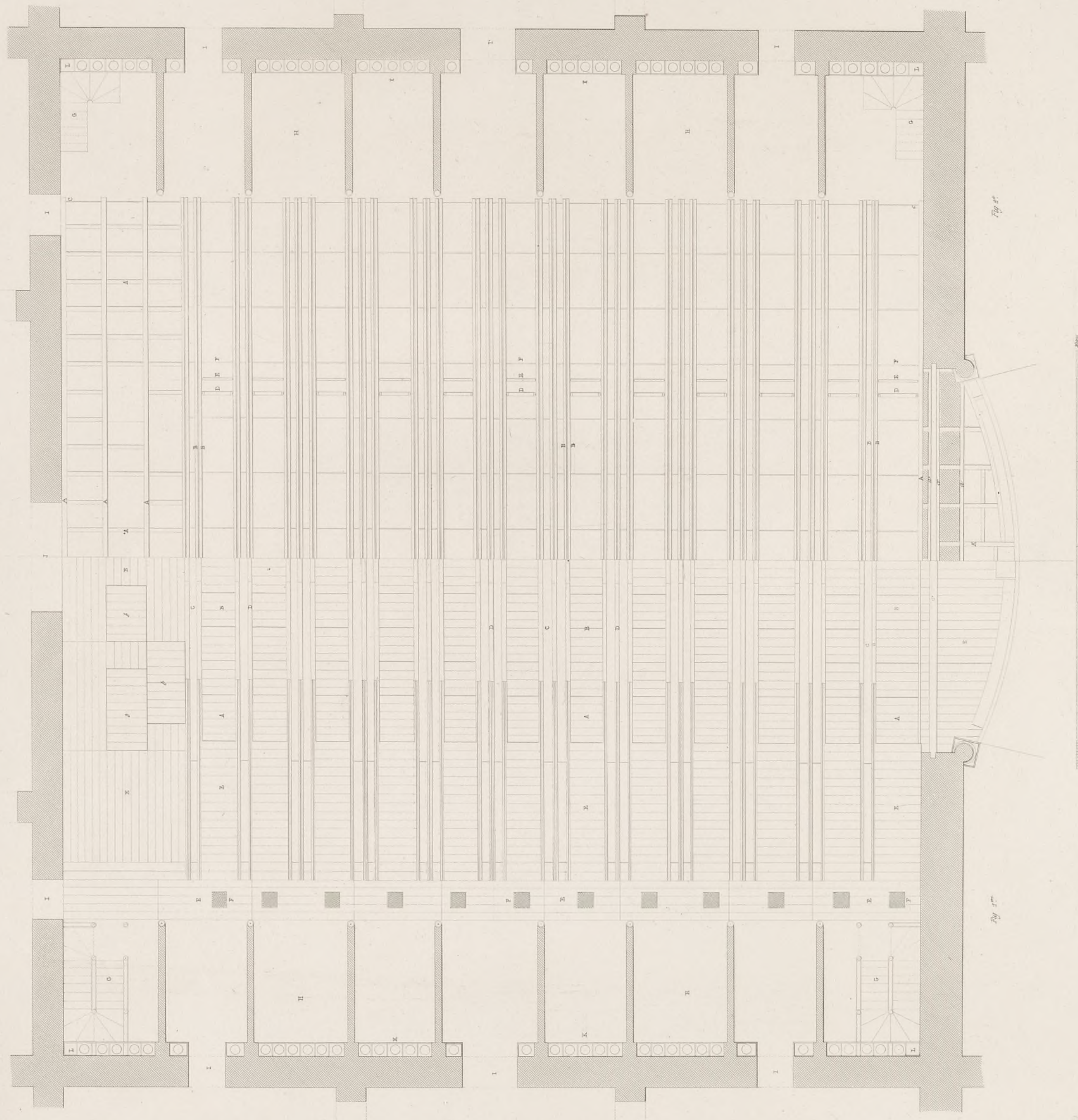

Fig 2^e

Fig 1^{re}



Alberik Zakrevski. sc.

C. Goussier. del.



PLAN DES CORRIDORS DE SERVICE, &c.
(SYST. FRANÇAIS)

Pl. 4

Fig. 2.

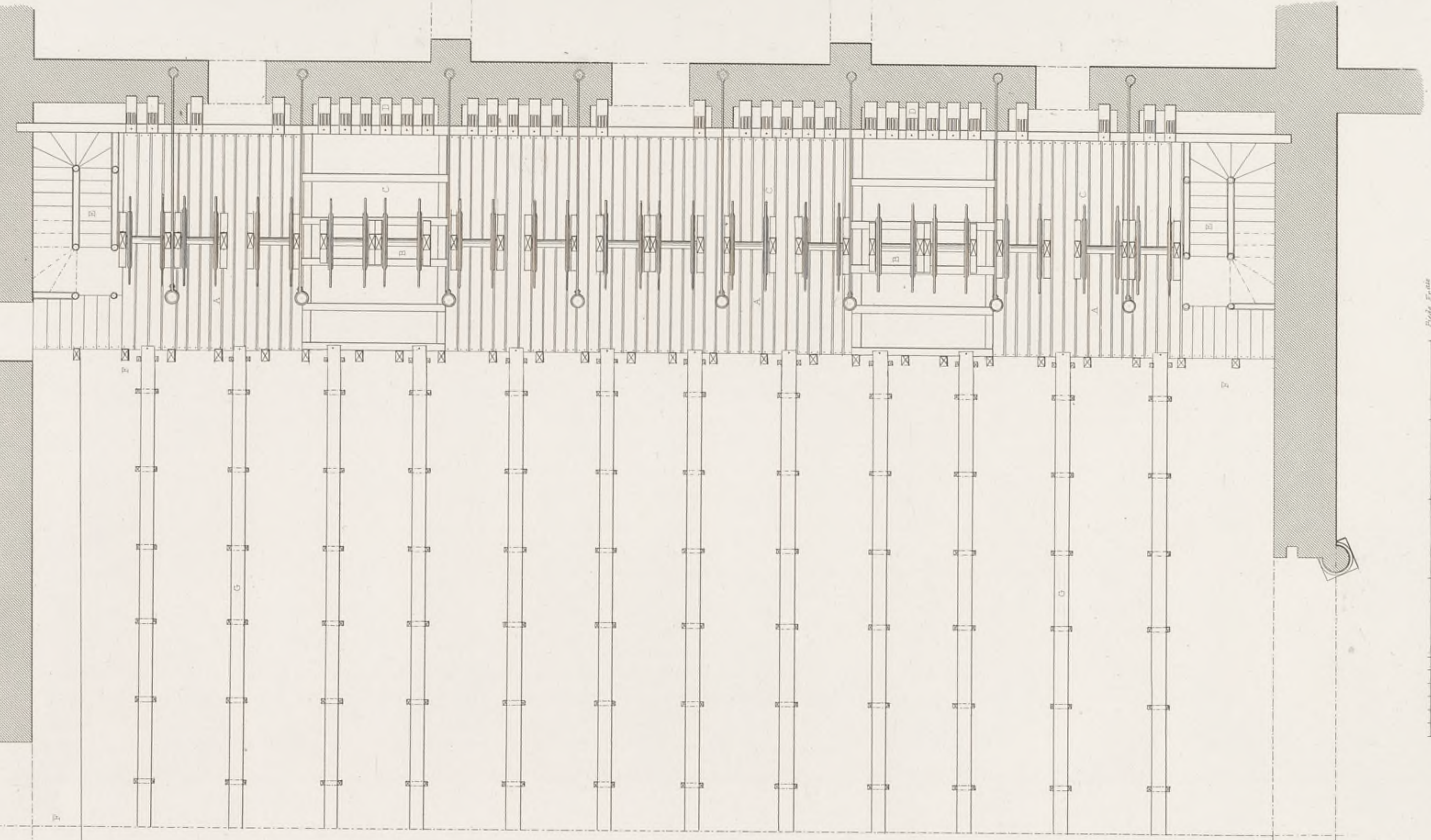
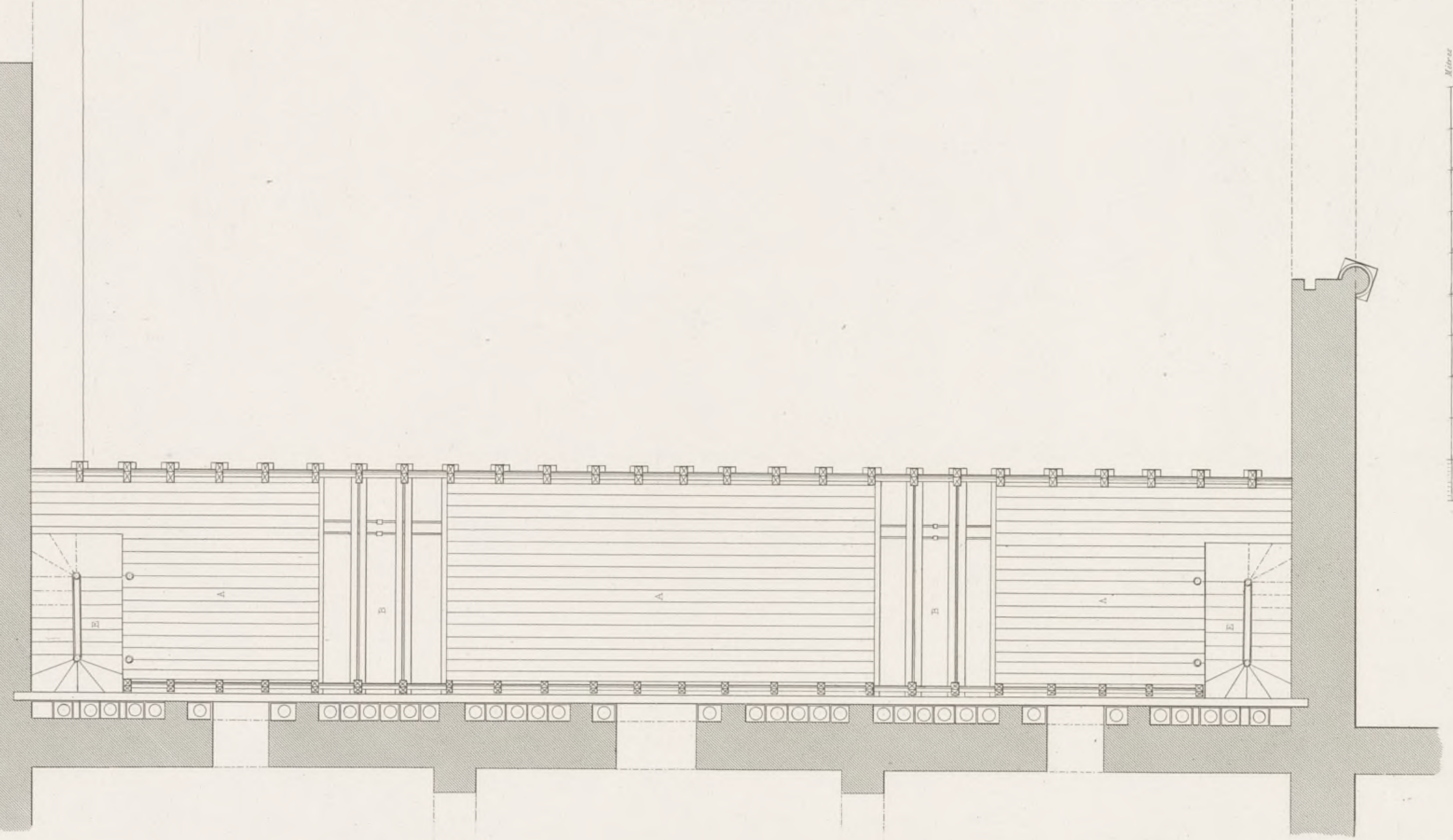

Fig. 1re



1/4 Scale 1/400

1/2 Scale 1/200

Alpha Birel, ac

C. Constant, del.

PLAN DU GRAND GRIL DU THÉÂTRE AVEC TAMBOURS, MOUFLES &
(Syst. Français)

Fig. 1^{re}

Fig. 2^e

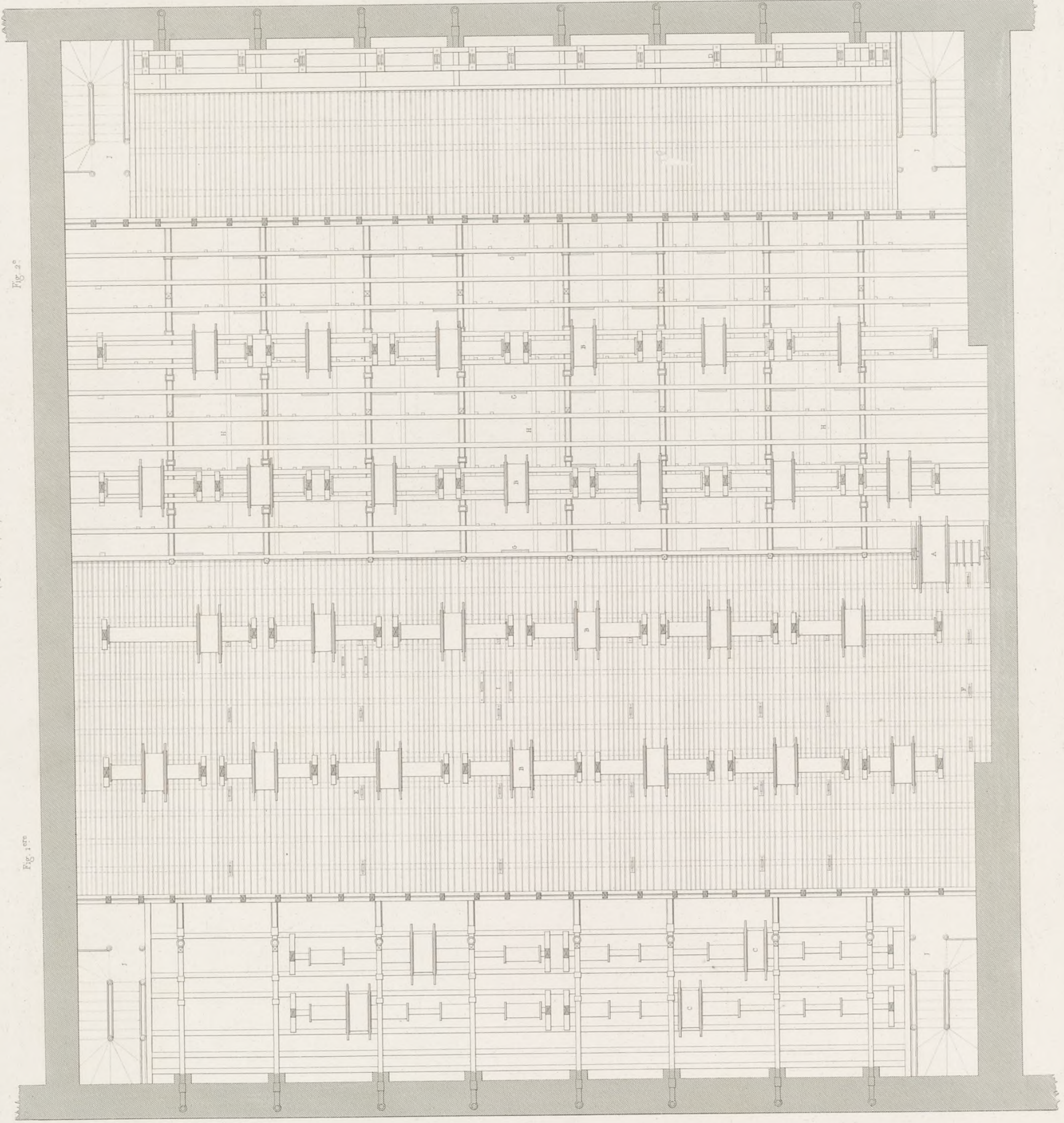

© Constant del.

Mètres

Pieds Français

Martin del.

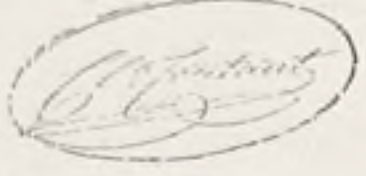

PLANTATION D'UN SALON FERMÉ, ET D'UNE GRANDE DÉCORATION EN PANORAMA, AVEC PRATICABLES, ESCALIERS, &c.
(SYSTÈME FRANÇAIS.)

Pl. 6.

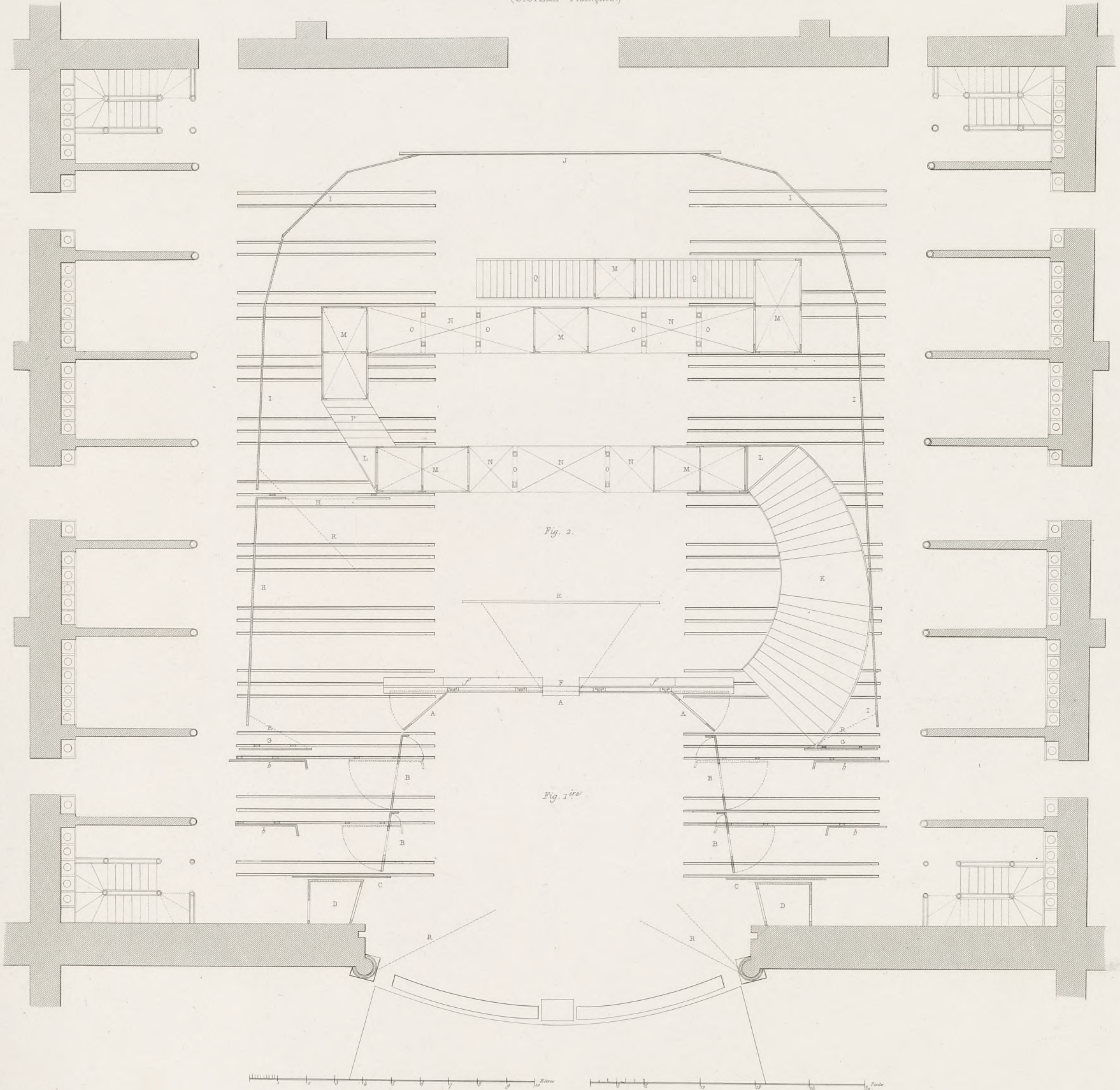

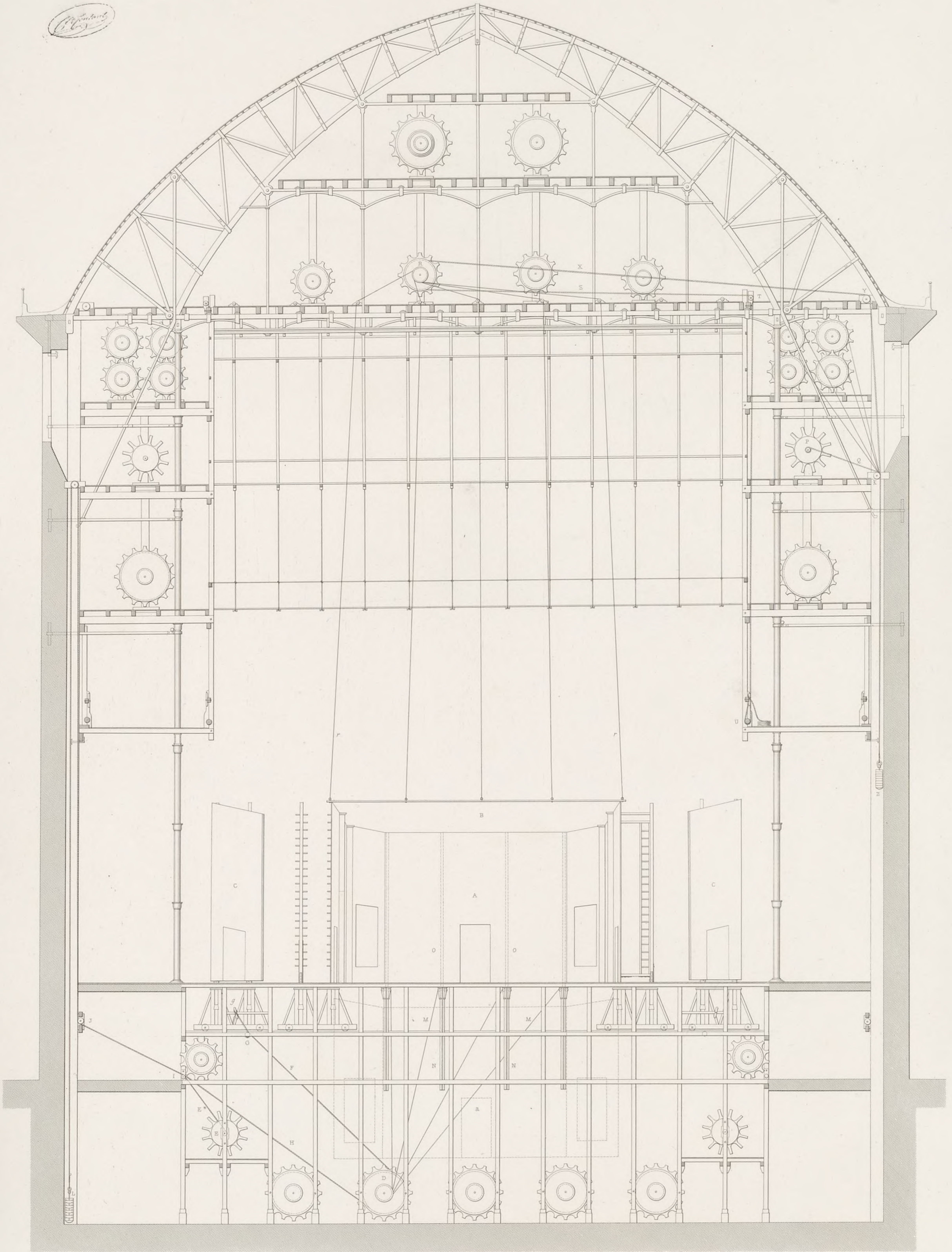

Mètres
Pieds Français



COUPE LONGITUDINALE AVEC ÉQUIPES D'UN SALON FERMÉ, DÉCORATION EN PANORAMA ET PRATICABLES.
(SYST. FRANÇAIS.)

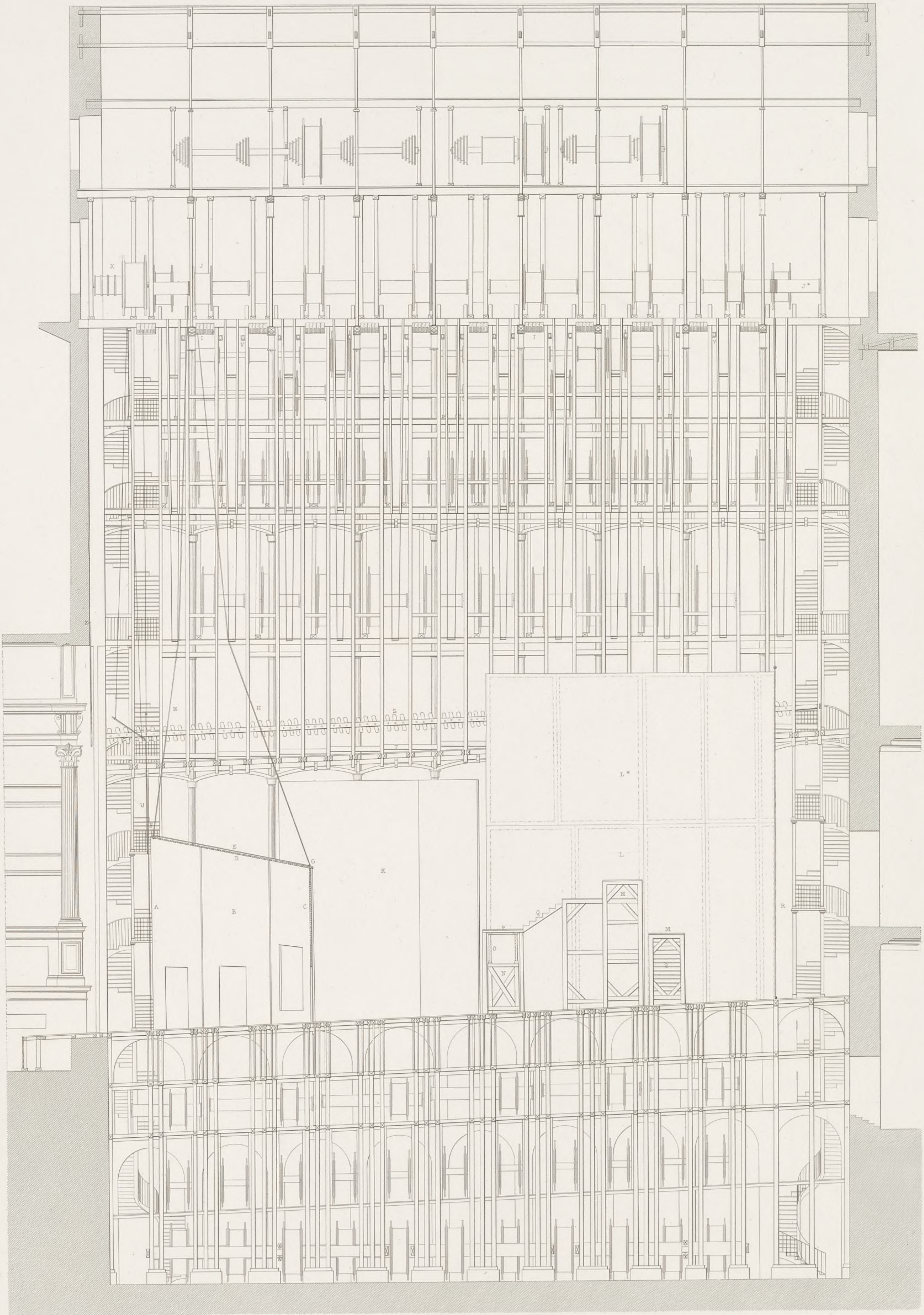



COUPE TRANSVERSALE AVEC ÉQUIPE DES GLOIRES, VOLS, TRAPPES, CHANGEMENT À VUE, &c.
(SYST. FRANÇAIS.)

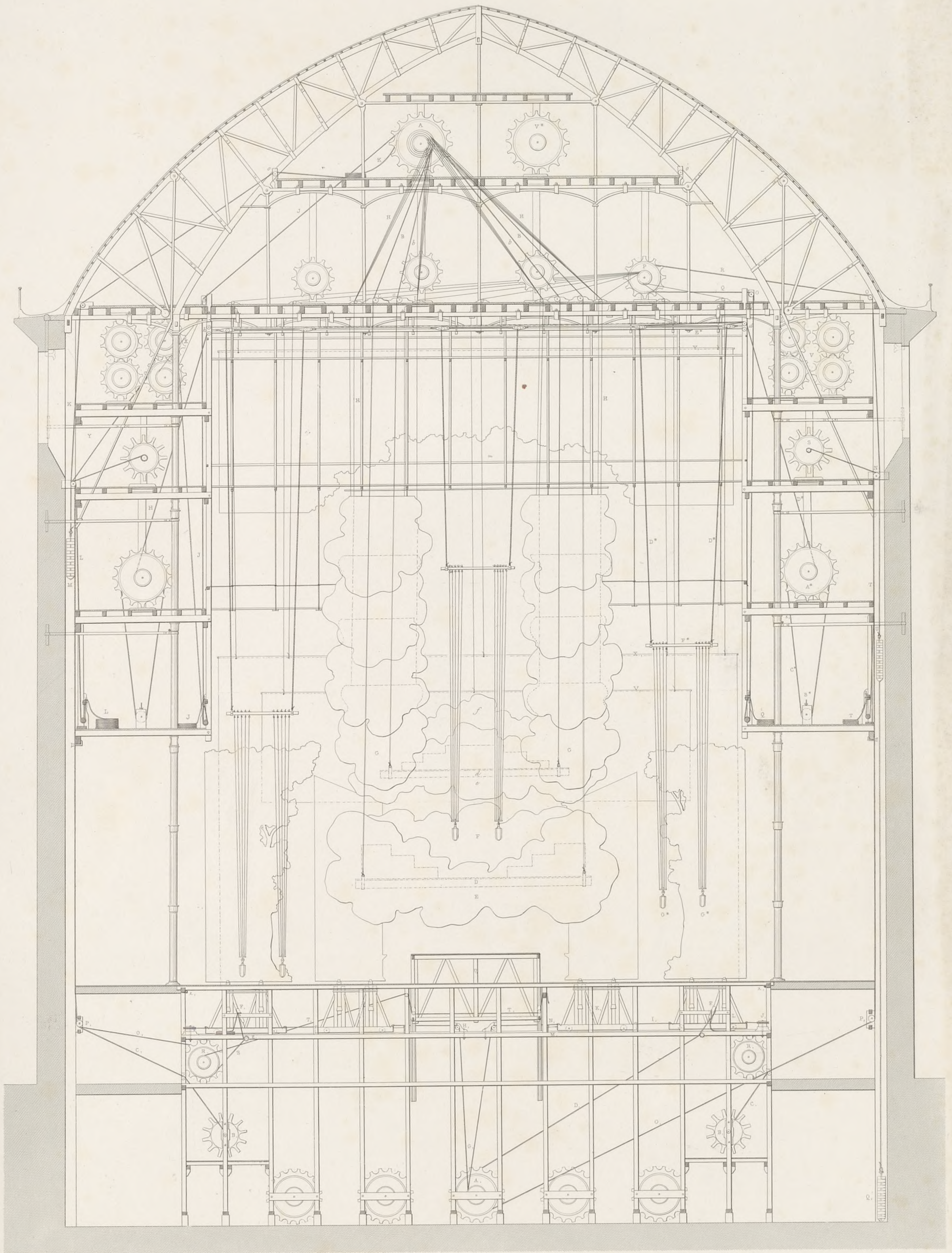

1/2 Pieds Fr. 1/2 Mètres



COUPE LONGITUDINALE DU THÉÂTRE AVEC ÉQUIPE DES VOLS, CLOIRES, &^a
(SYST. FRANÇAIS)

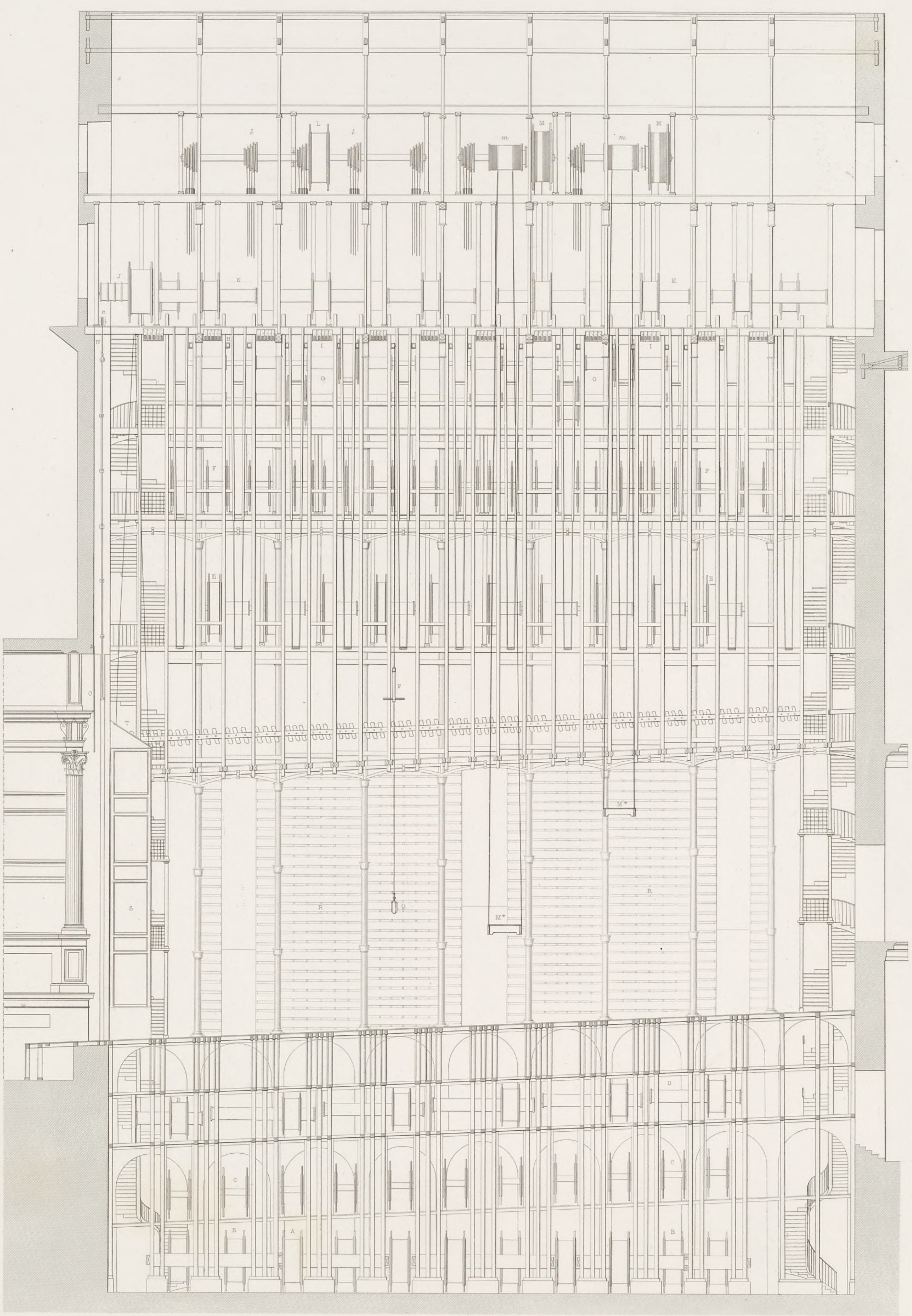

COUPE TRANSVERSALE DU CINTRE, ÉQUIPE D'UN VOL TOURNANT, RAMPE DE GAZ, &^a
(SYST. FRANÇAIS)

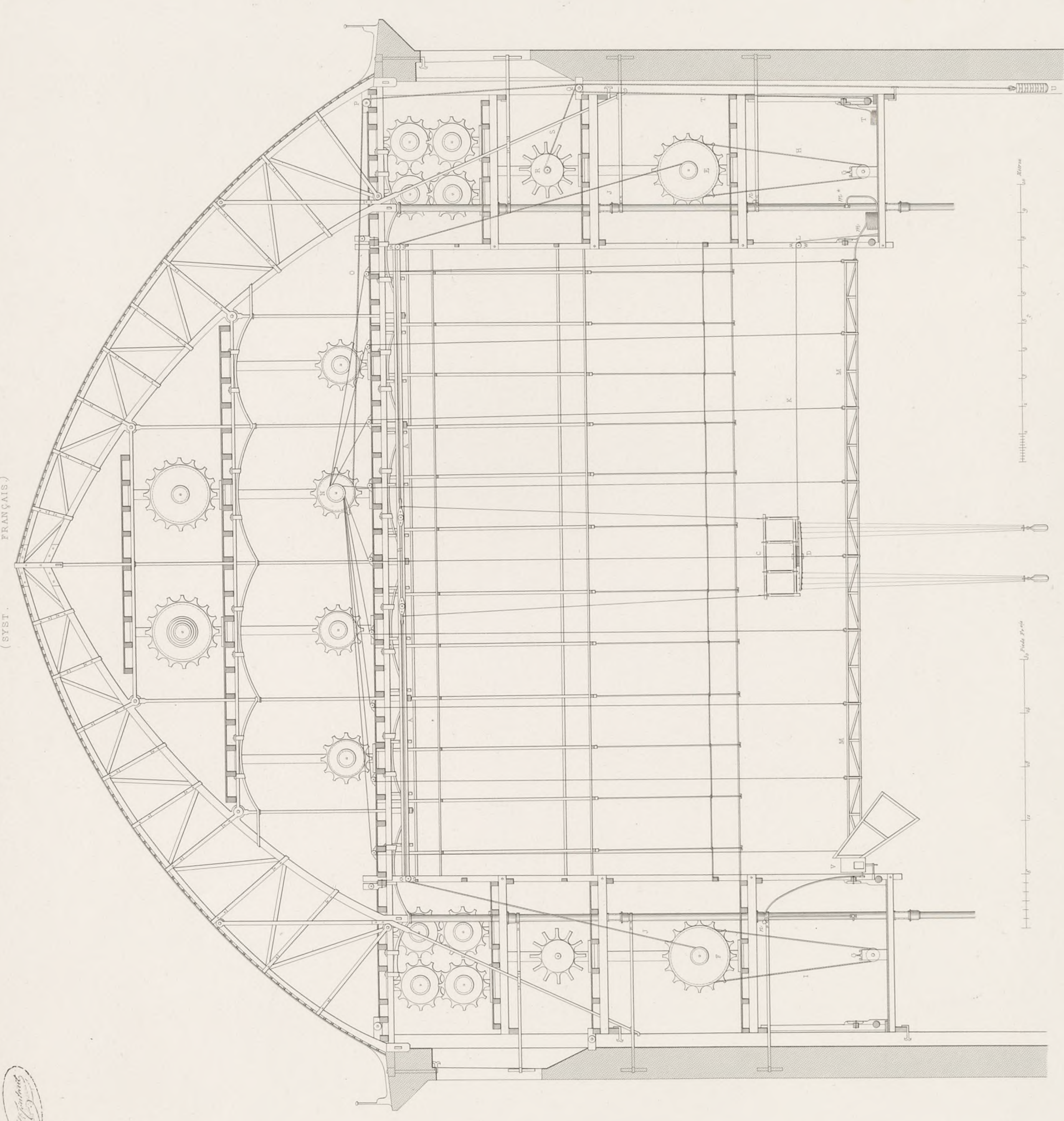

ÉQUIPE D'UNE FERME ISOLÉE AVEC SON PLAFOND.
(SYST. FRANÇAIS)

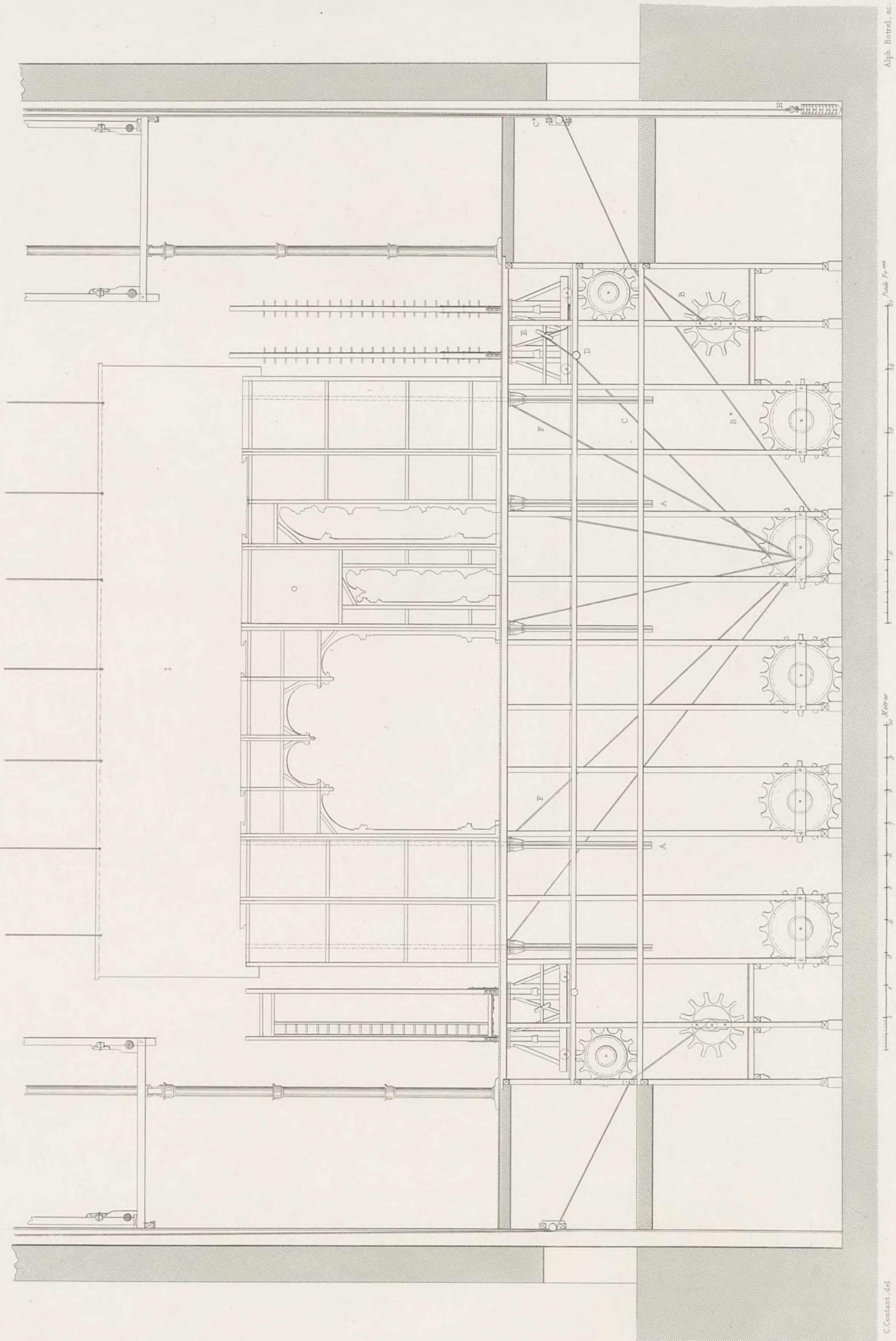

C. Content - ad.

Alph. Berrol, sc.

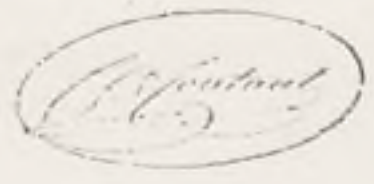

DÉTAILS DE FERRURES EN USAGE AU CEINTRE DU THÉÂTRE, POUR VOLS, GLOIRES, &c.
(SYSTÈME FRANÇAIS)

Pl. 13.

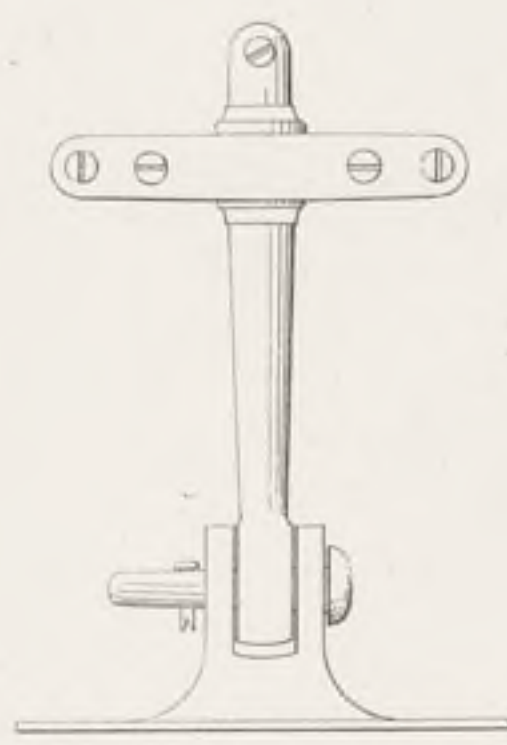
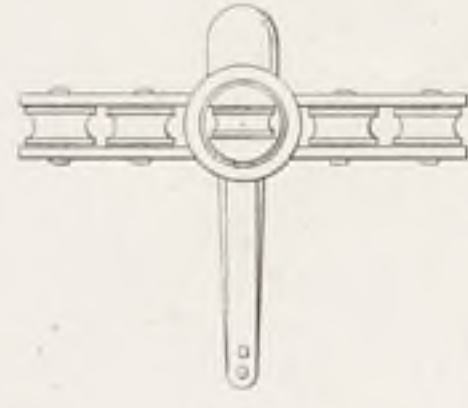

Fig. 1^{ère}



Fig.



2.

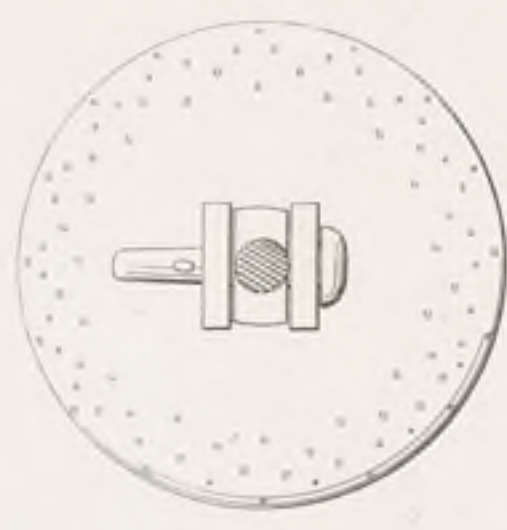
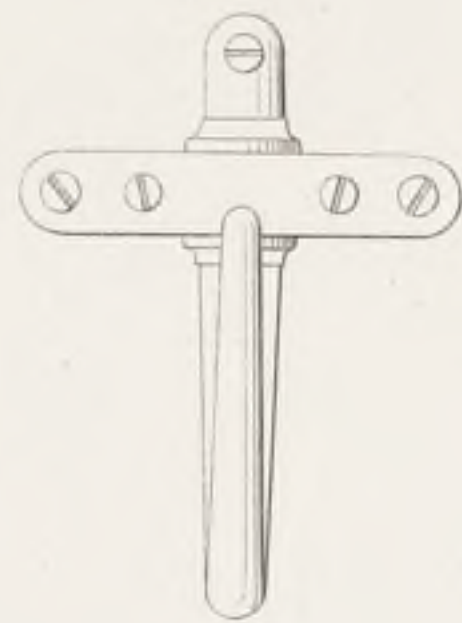

Fig. 3.

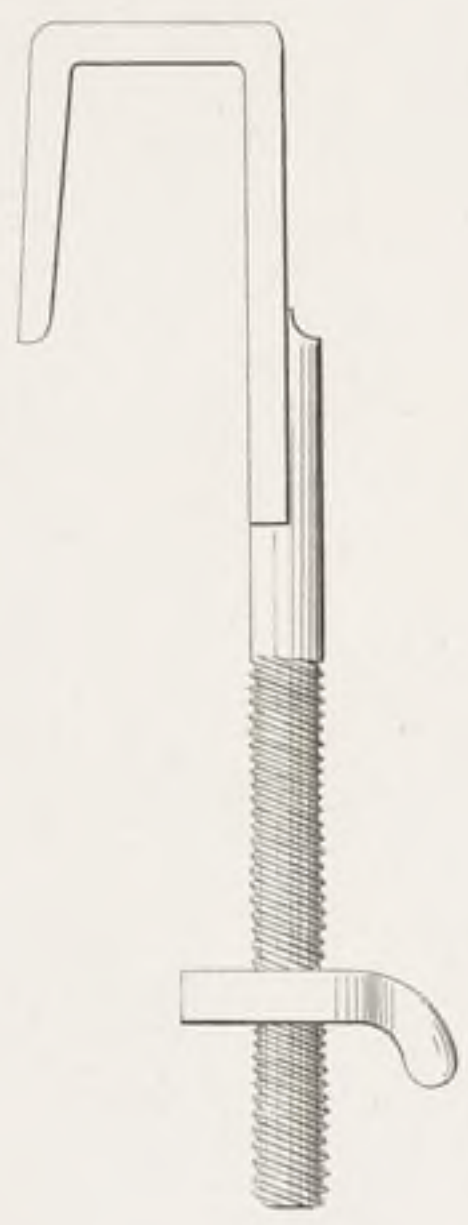

Fig. 4.

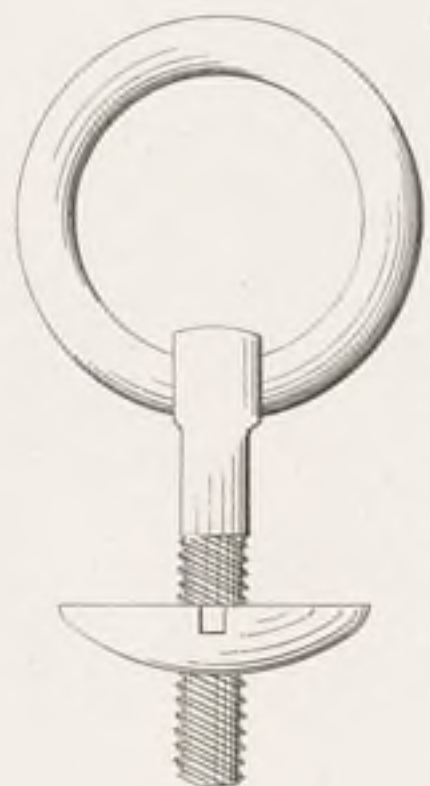

Fig. 5.



Fig. 7.



Fig. 6.

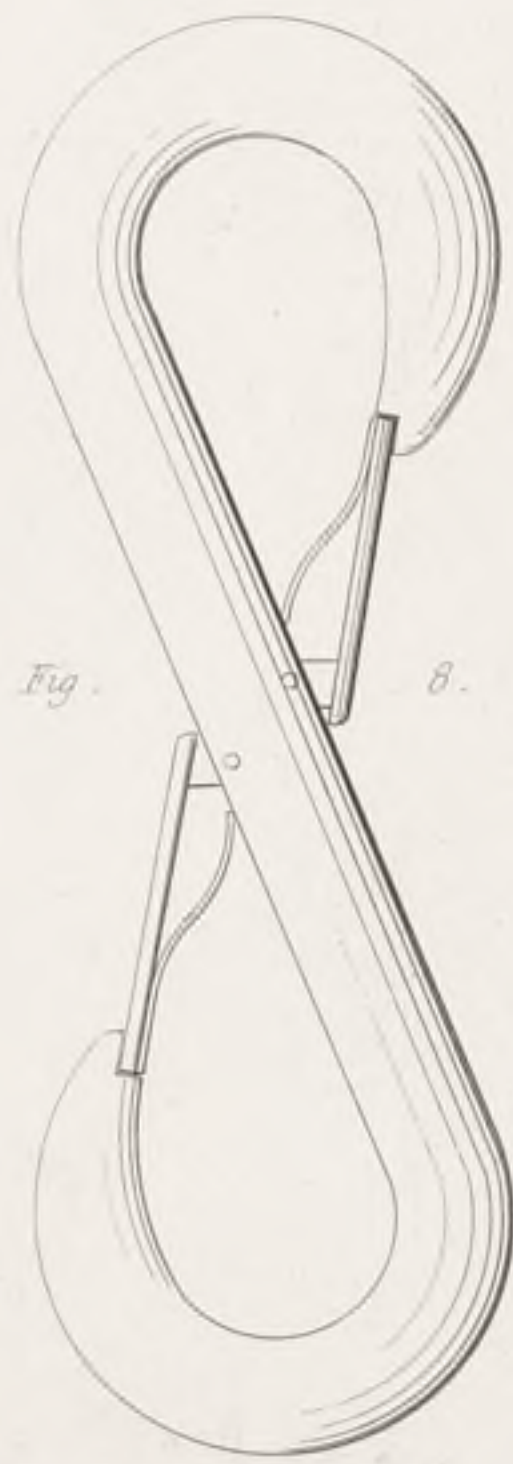

Fig. 8.

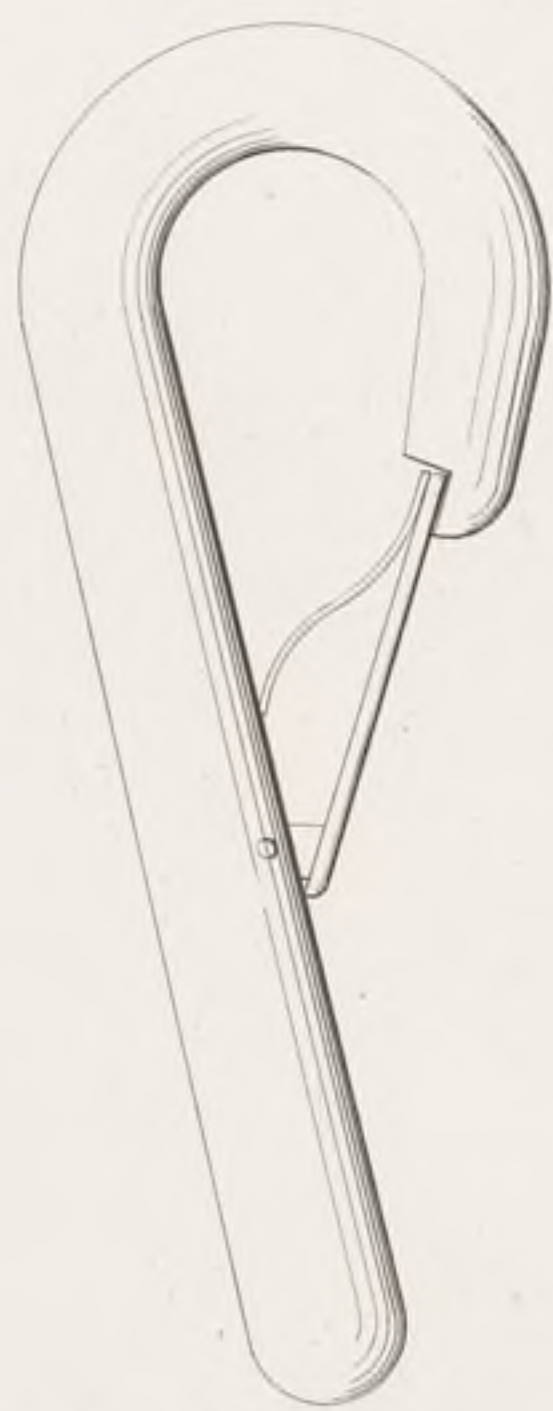

Fig. 9.

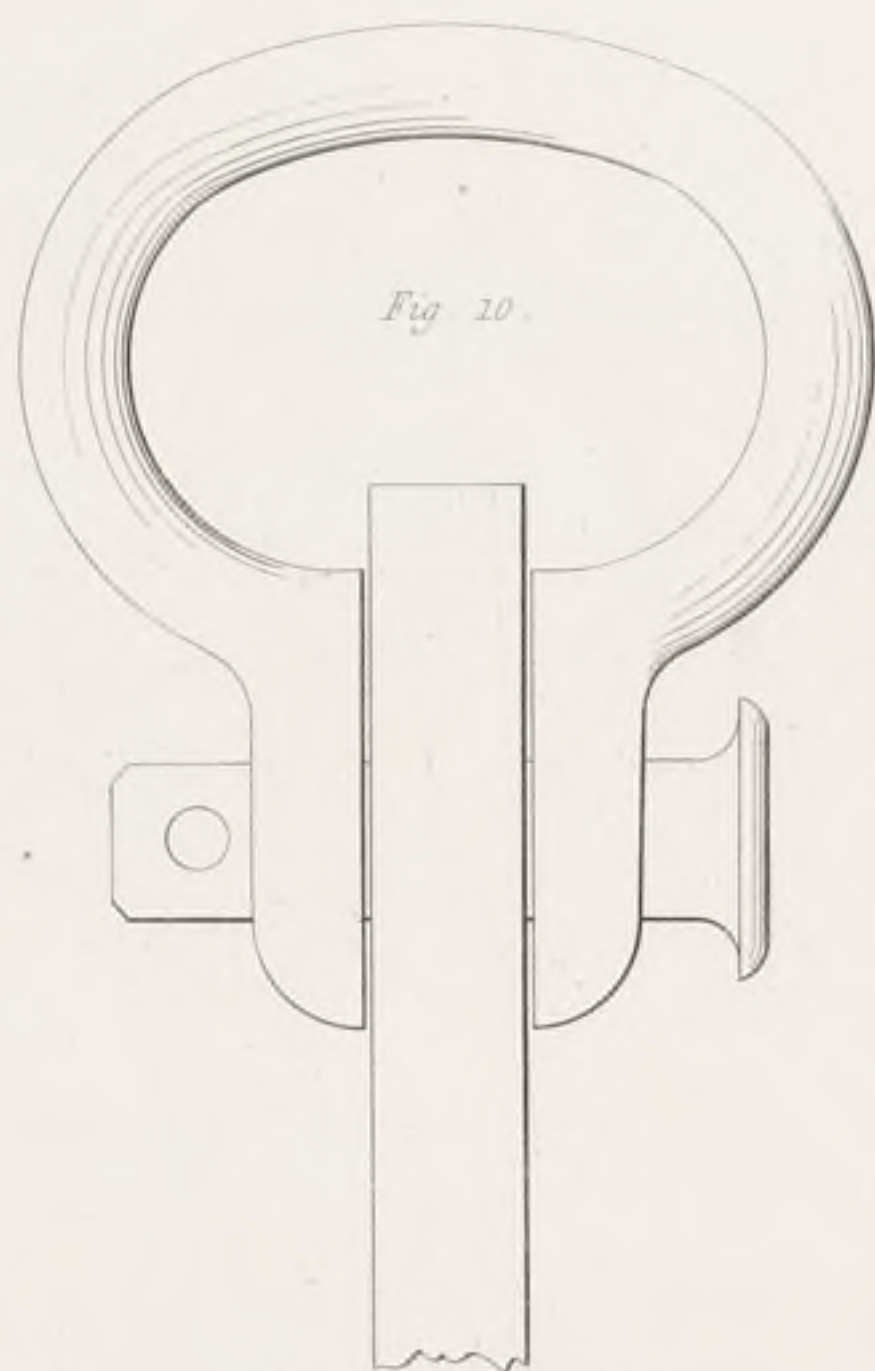
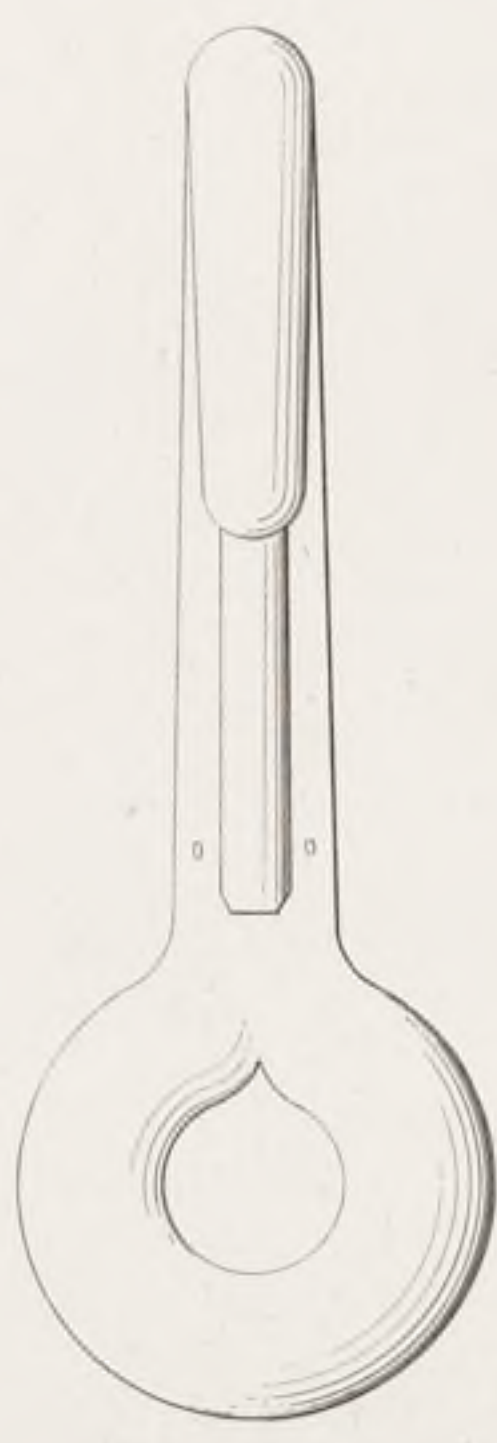
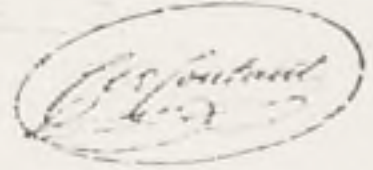

Fig. 10.



DETAILS DES MOUFLES, CONTREPOIDS ET MÉCANIQUES POUR LUSTRES.

Pl. 14

(SYST. FRANÇAIS)

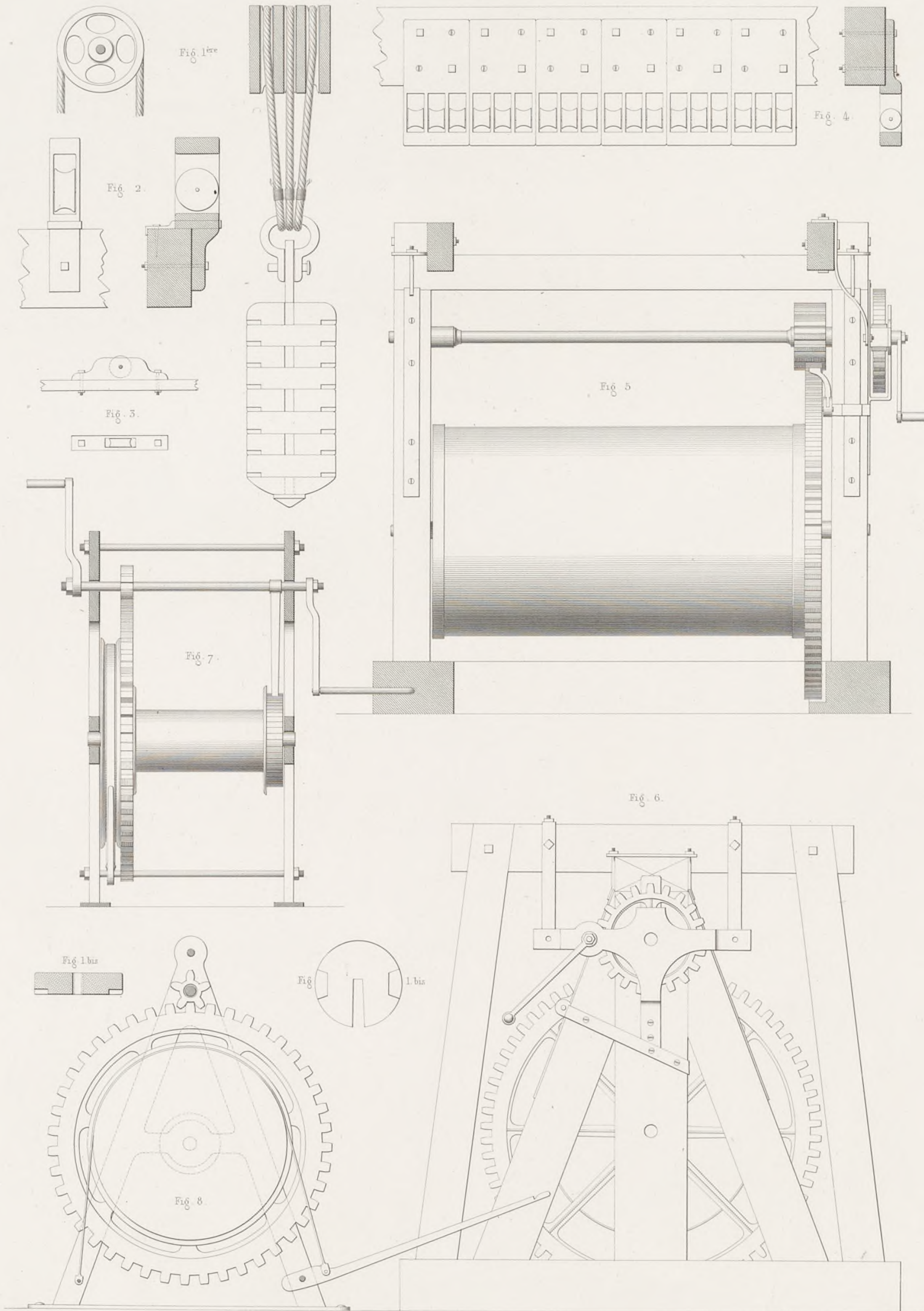

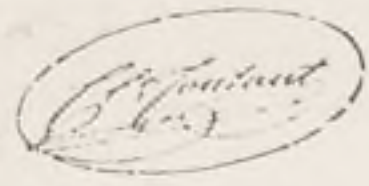

DÉTAILS DES RAMPES & BOITES À GAZ EN USAGE AU CINTRE DU THÉÂTRE.
(SYST. FRANÇAIS.)

Pl. 15

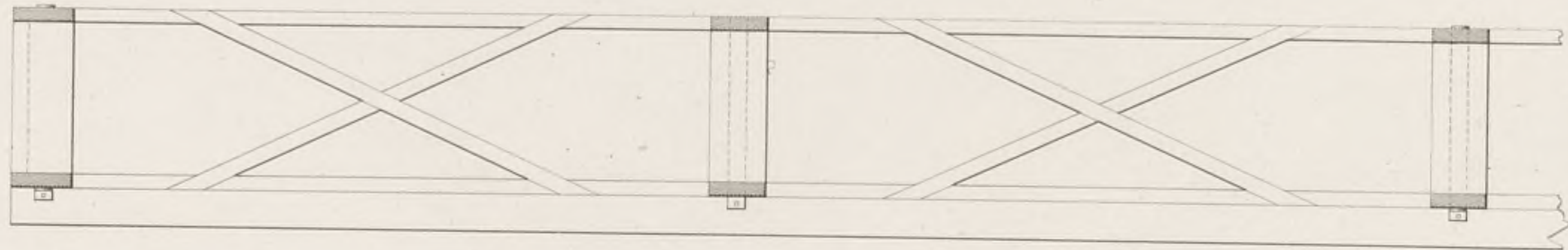

Fig. 1.

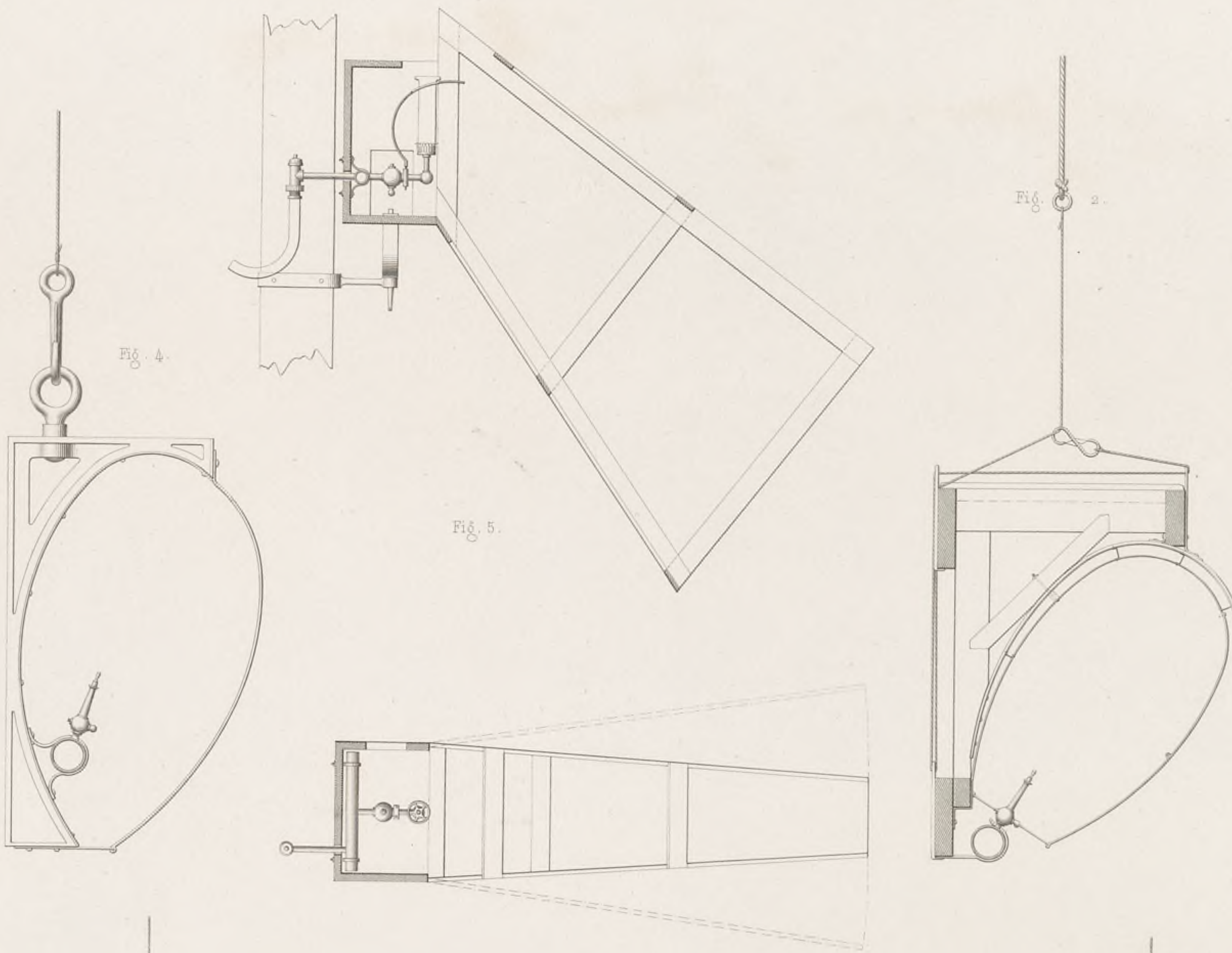
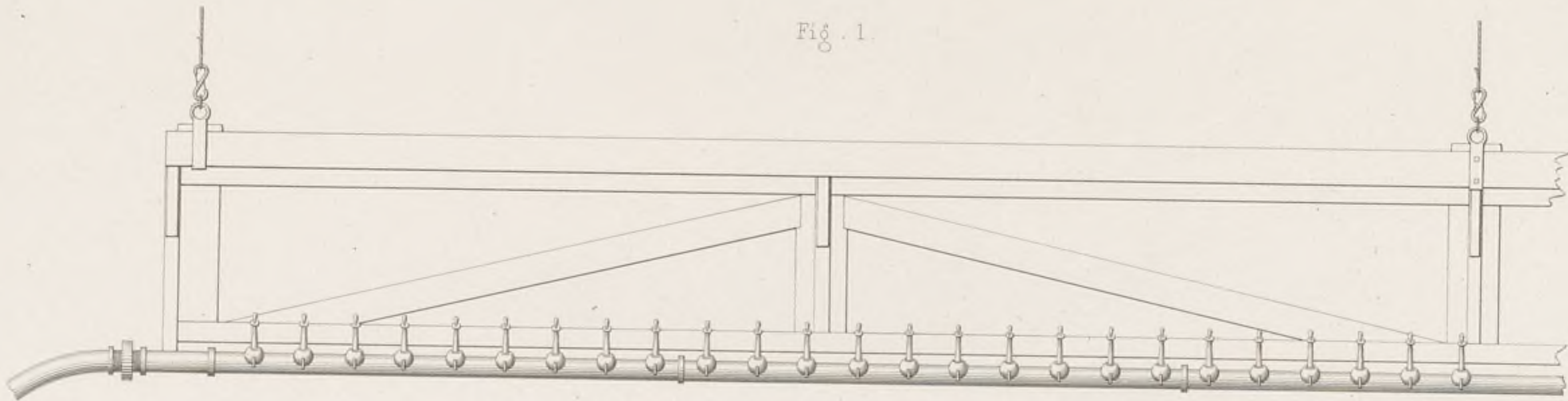
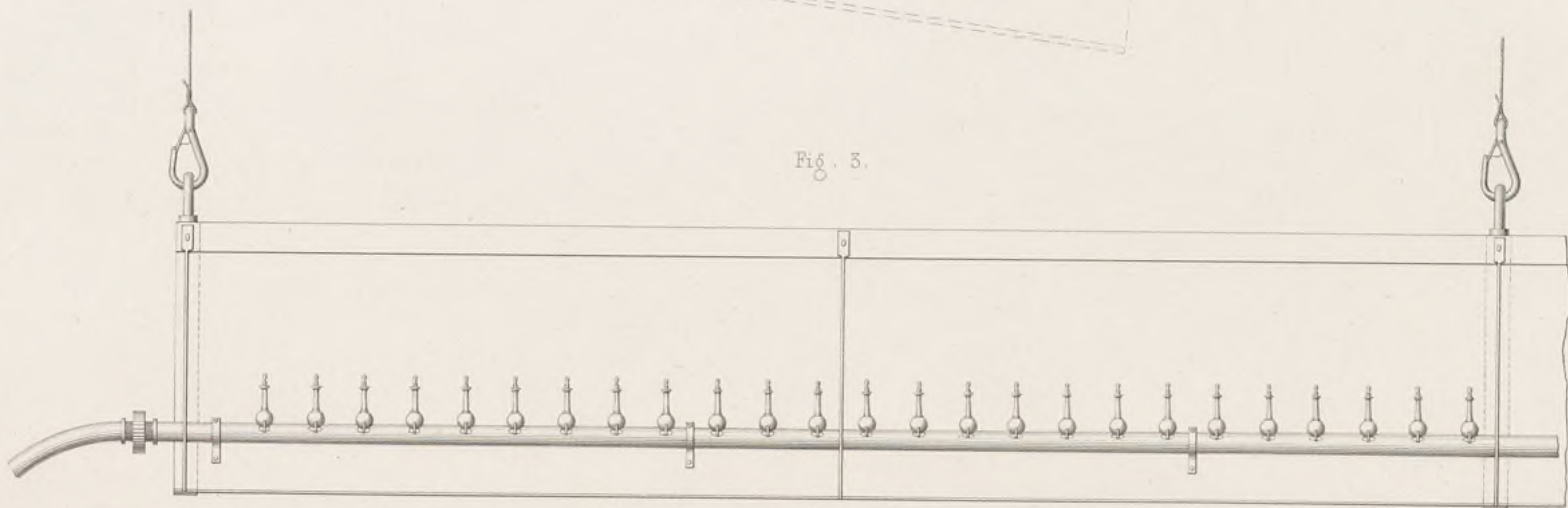

Fig. 4.

Fig. 5.

Fig. 6.

Fig. 3.



G. Contant del.

J. Petitcolin sculp.

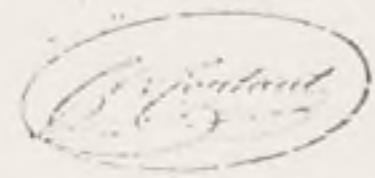

DÉTAILS D'UN PORTANT DE CHASSIS ET D'UNE RAMPE POUR TERRAINS,
TRAVERSANT LE THÉÂTRE ÉCLAIRÉ PAR LE GAZ
(SYSTEME FRANÇAIS)

Pl. 16.

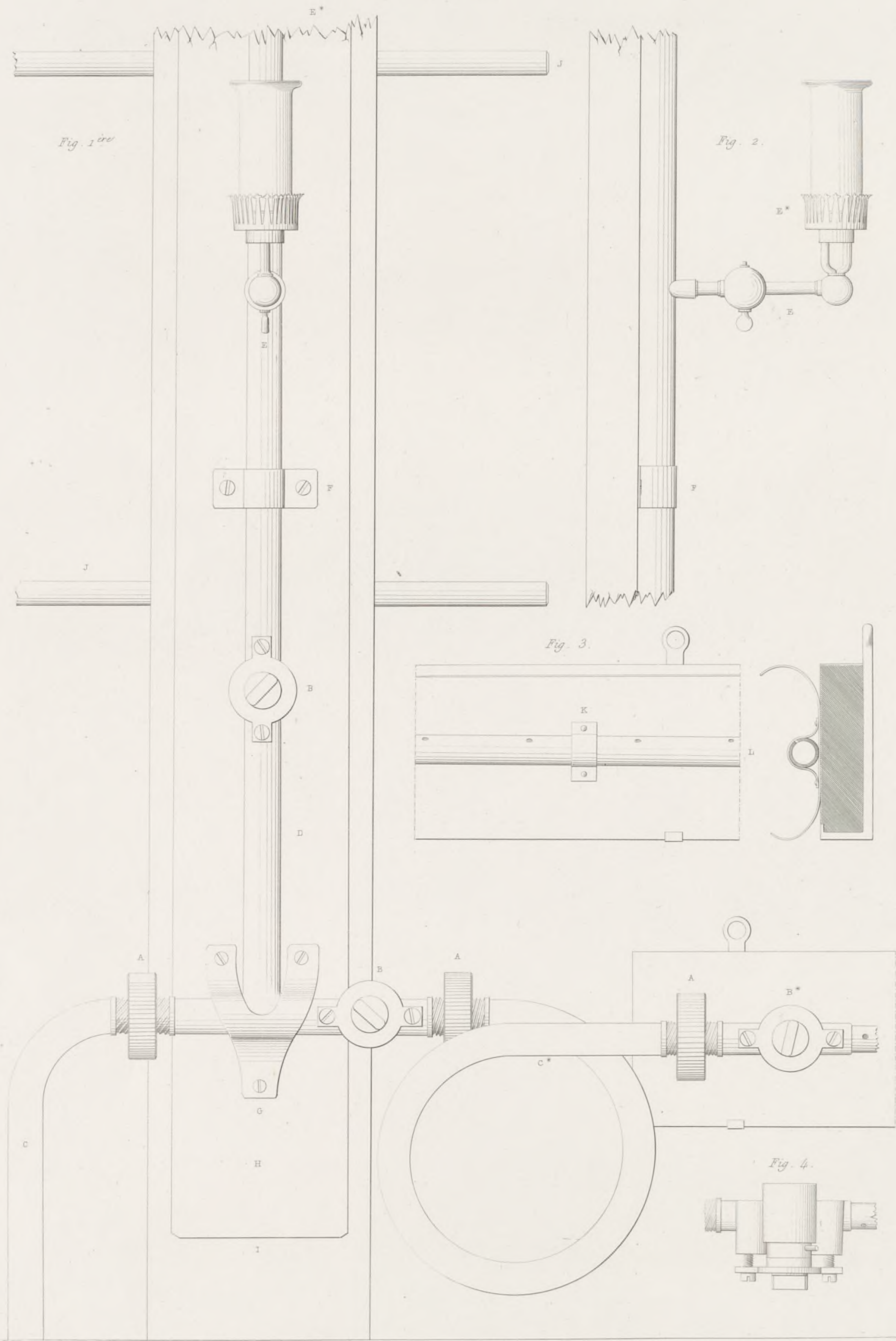

Contant

DÉTAILS DES FERRURES EN USAGE SUR LE THÉÂTRE.
(SYSTÈME FRANÇAIS)

Pl. 17.

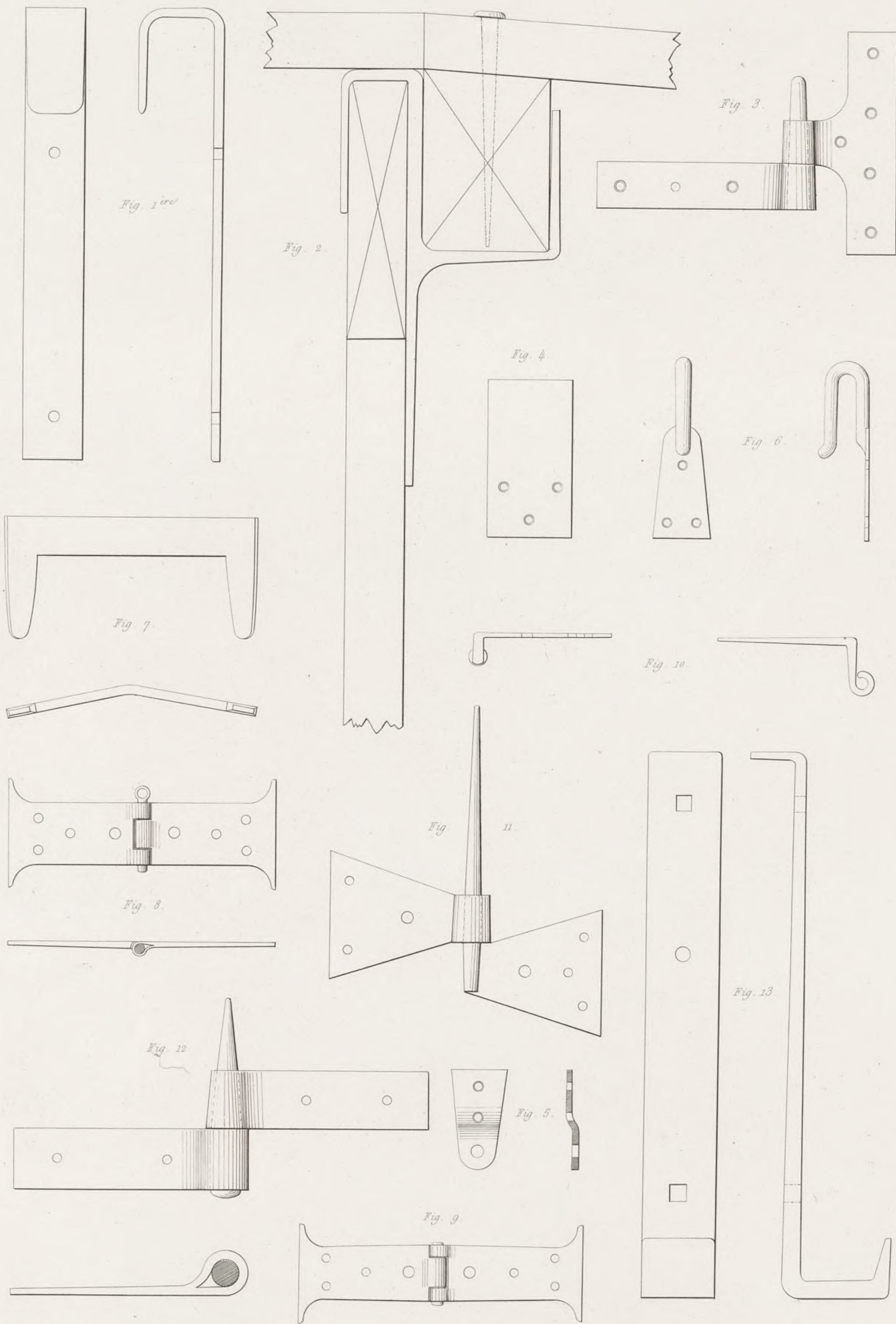

C. Contant, del.

Alph. Botrel, sc.

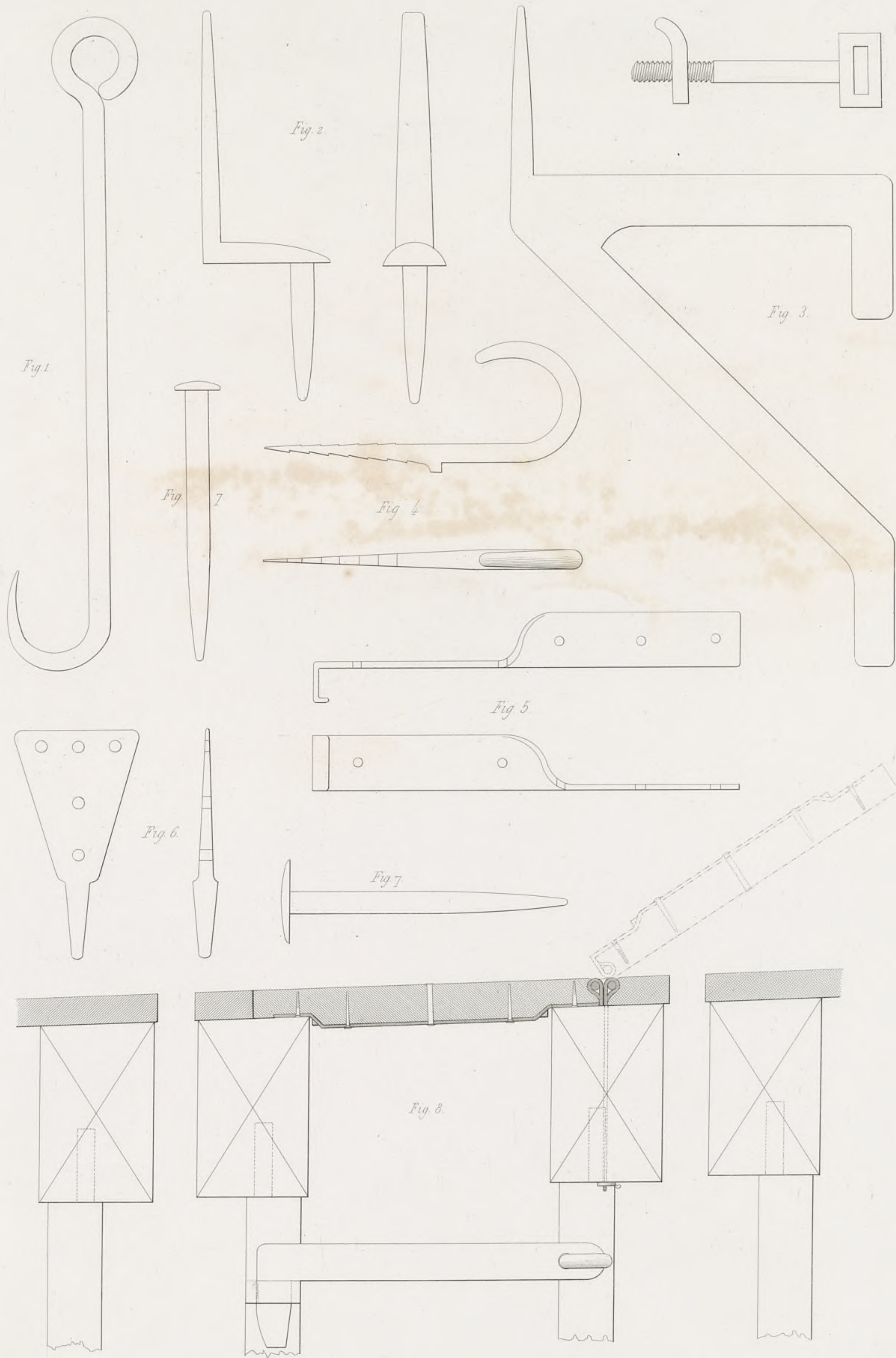
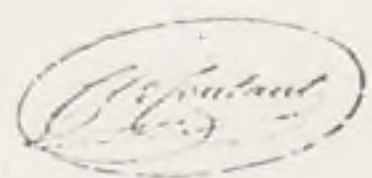

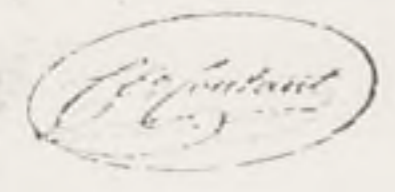

DÉTAILS DE CONSTRUCTION DES FERRURES &c À L'USAGE DU 1^{er} DESSOUS DU THÉÂTRE
(SYSTÈME FRANÇAIS)

Pl. 19

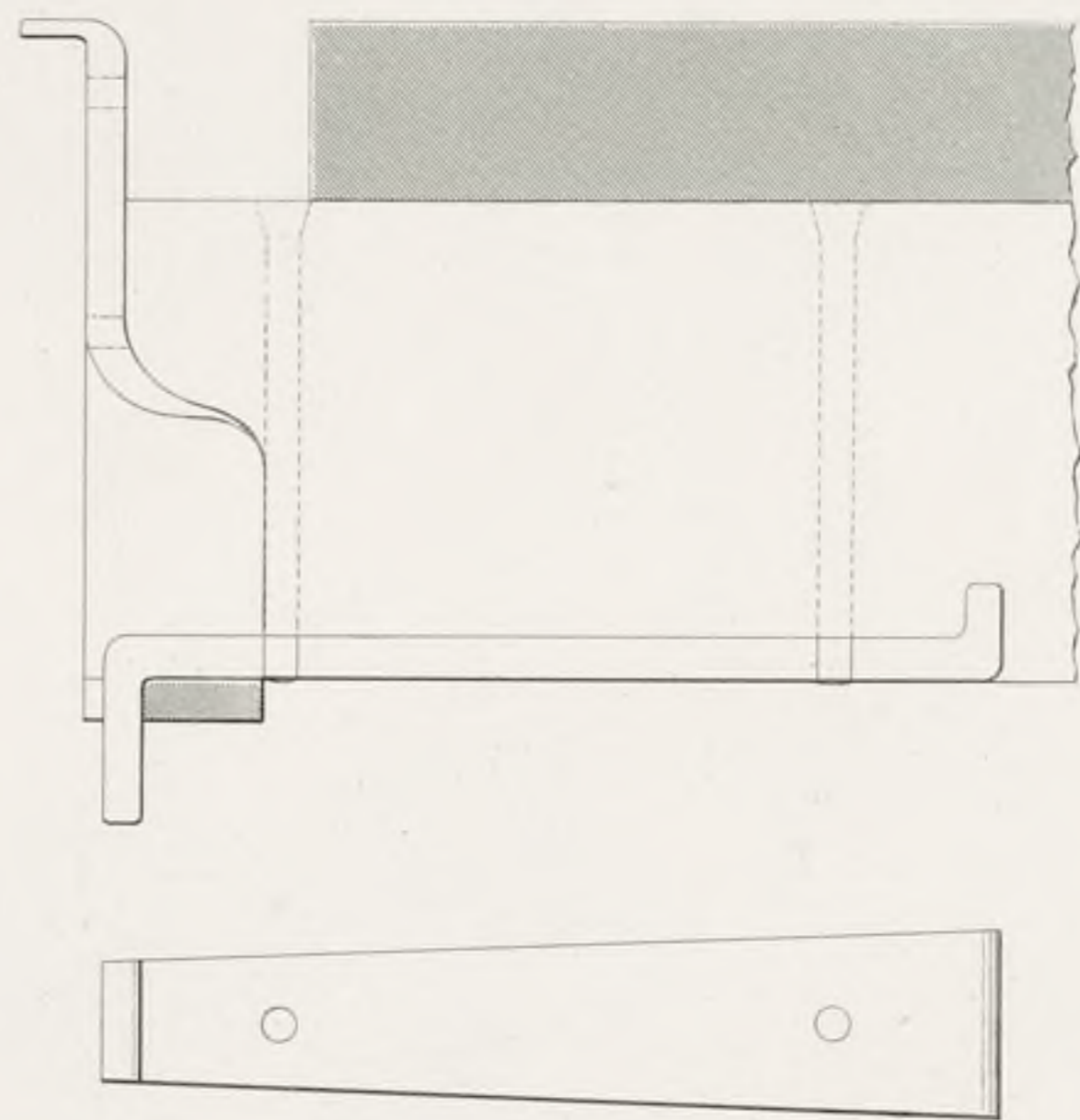
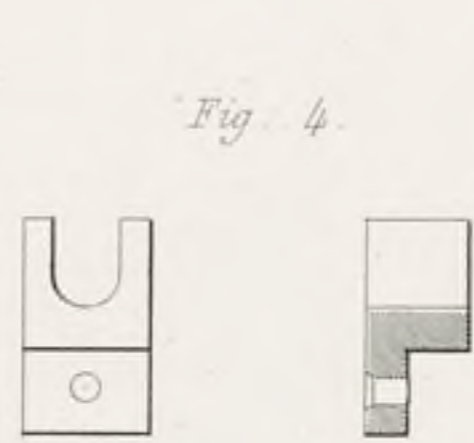
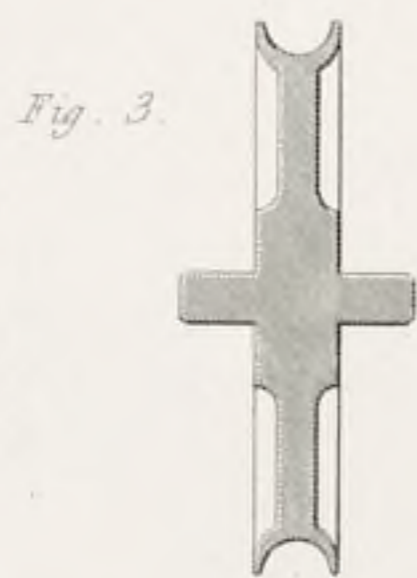
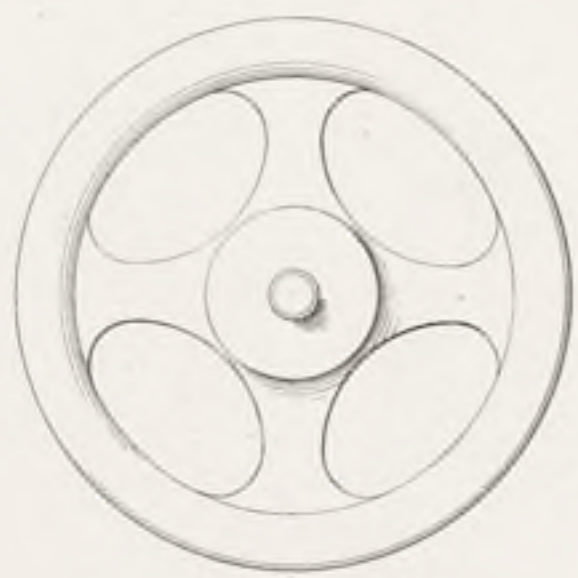
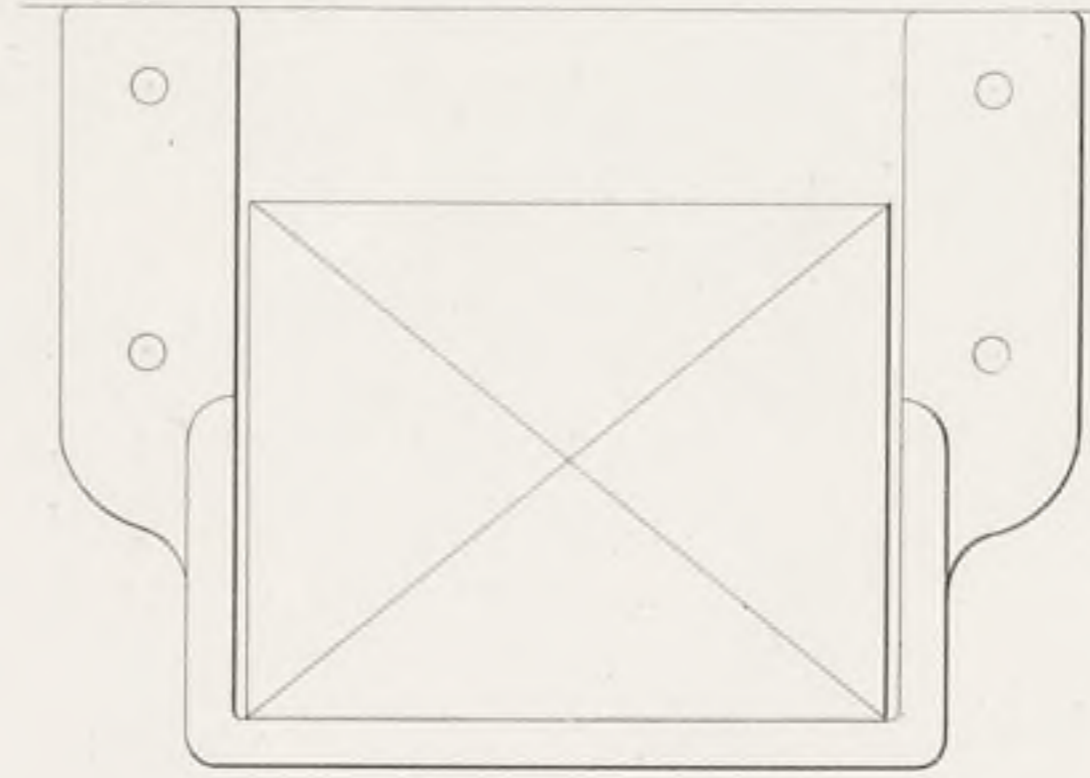
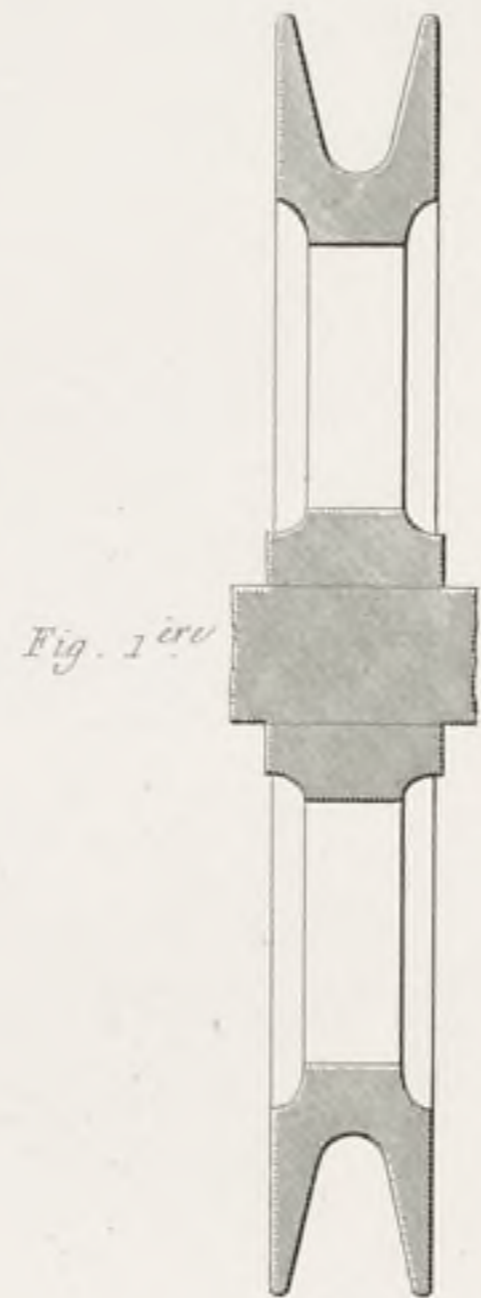
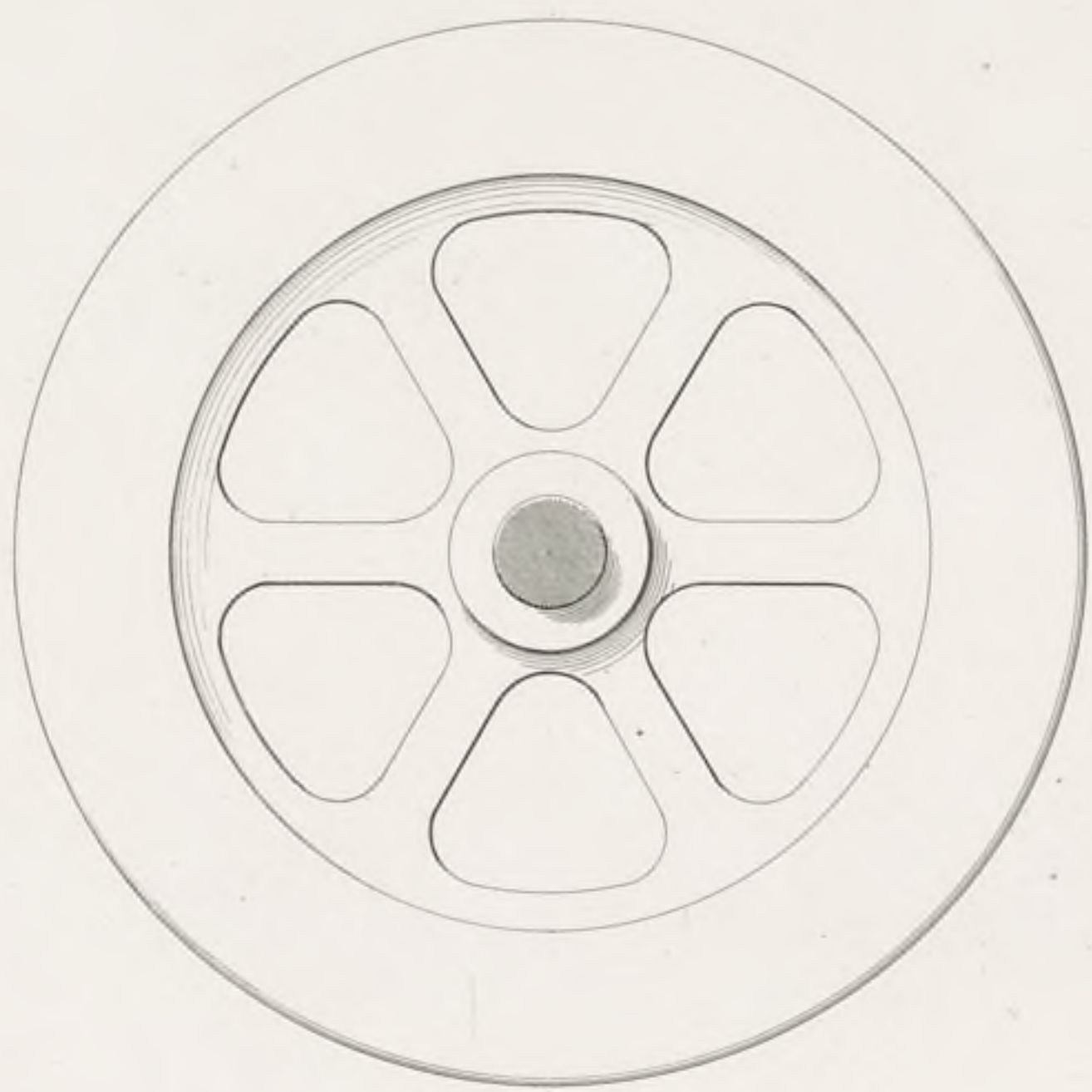

Fig. 5.

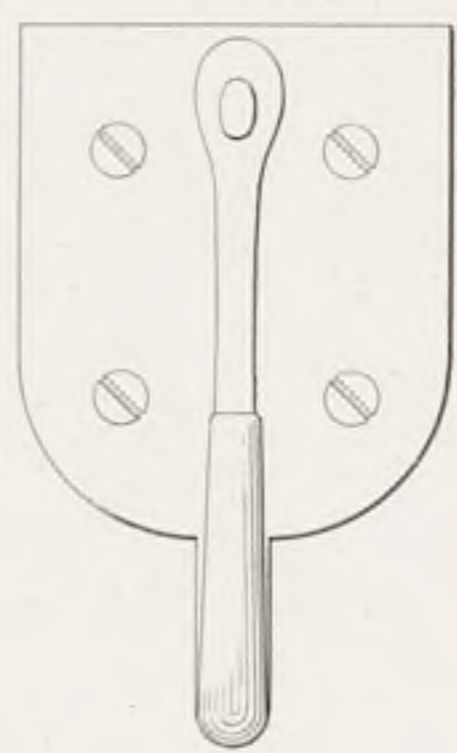

Fig. 6.

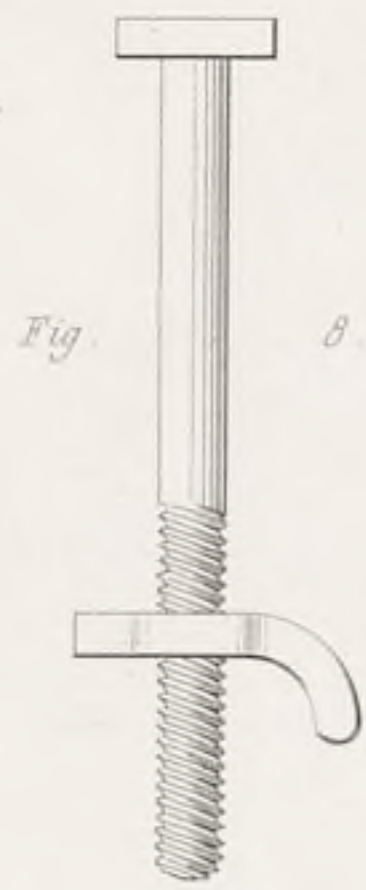

Fig. 8.



Fig. 10.

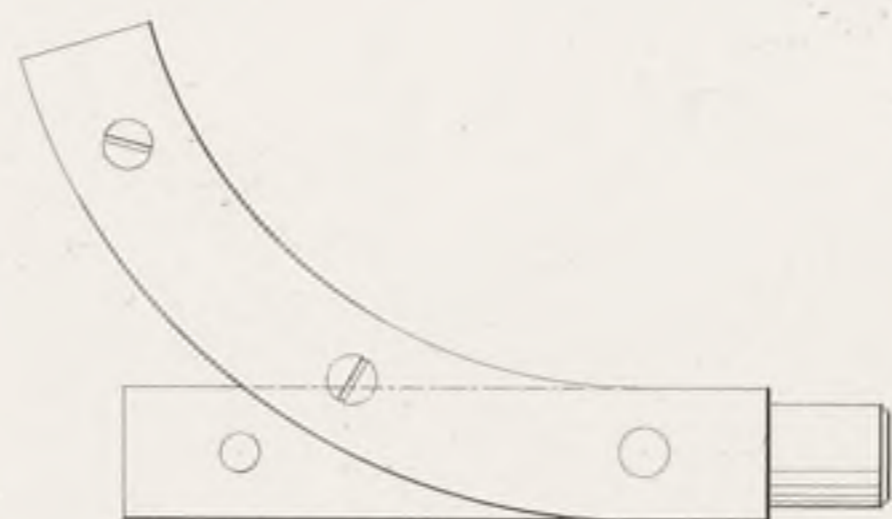

Fig. 11.

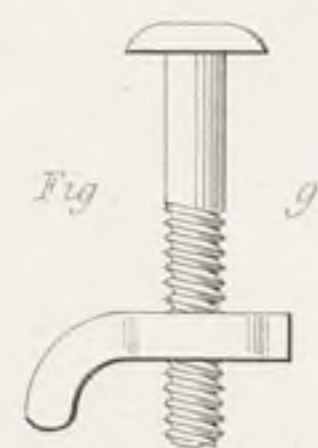
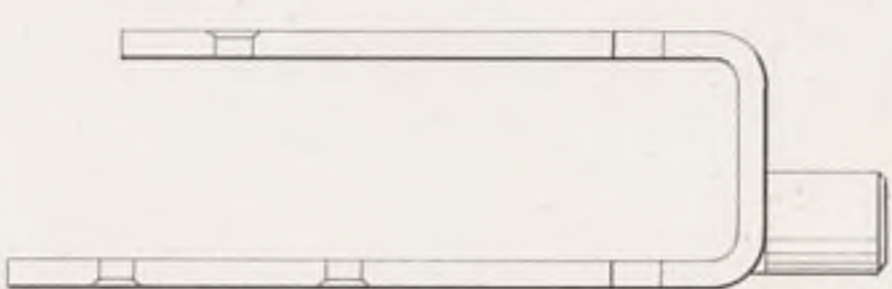
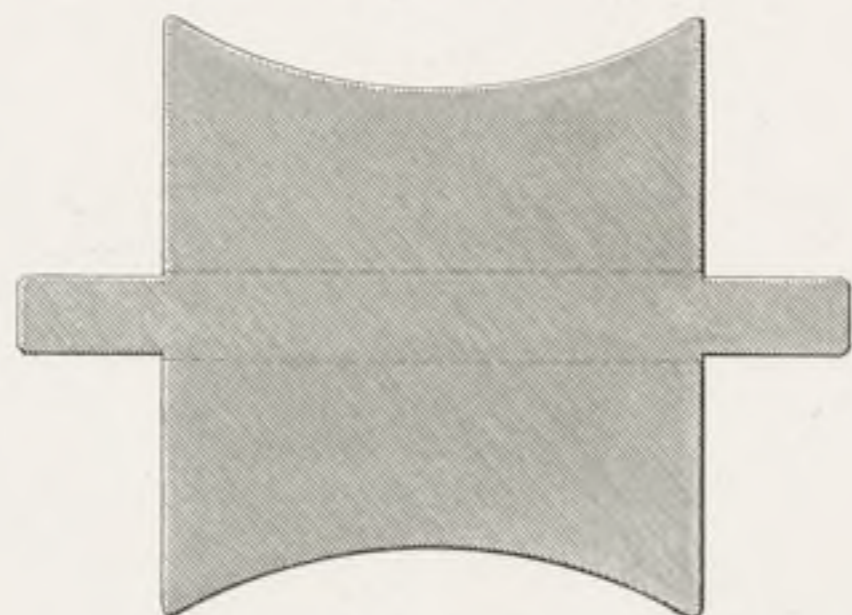
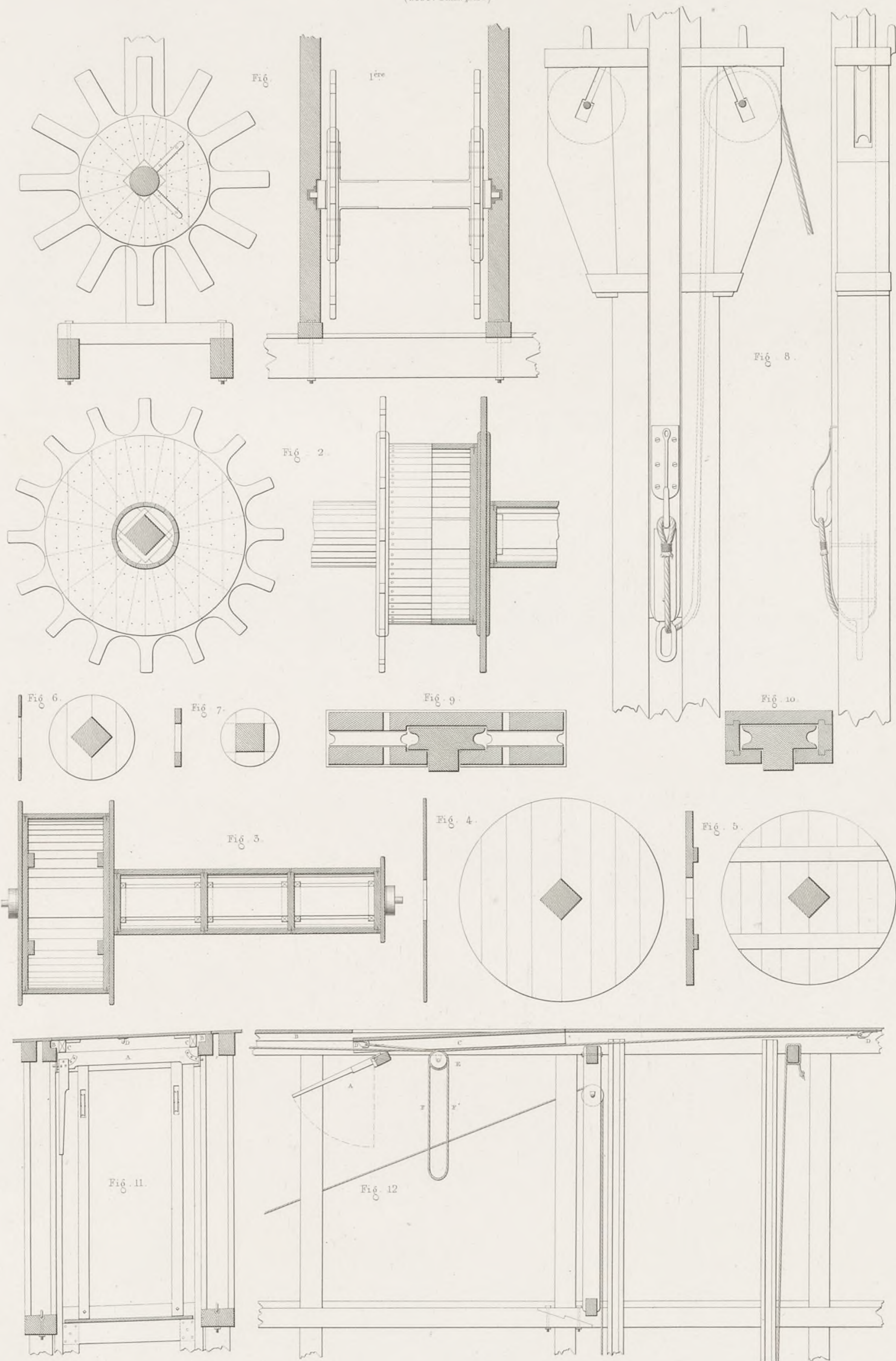
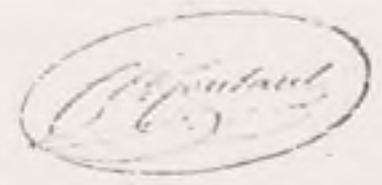
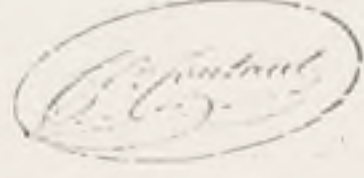

Fig. 9.







DÉTAILS DE CONSTRUCTION DES DESSOUS DU THÉÂTRE, DES MACHINES QUI Y SONT EN USAGE
ET D'UNE CASSETTE AVEC CHAR POUR DES VOLS DU CEINTRE.
(SYSTEME FRANÇAIS)

Pl. 21.

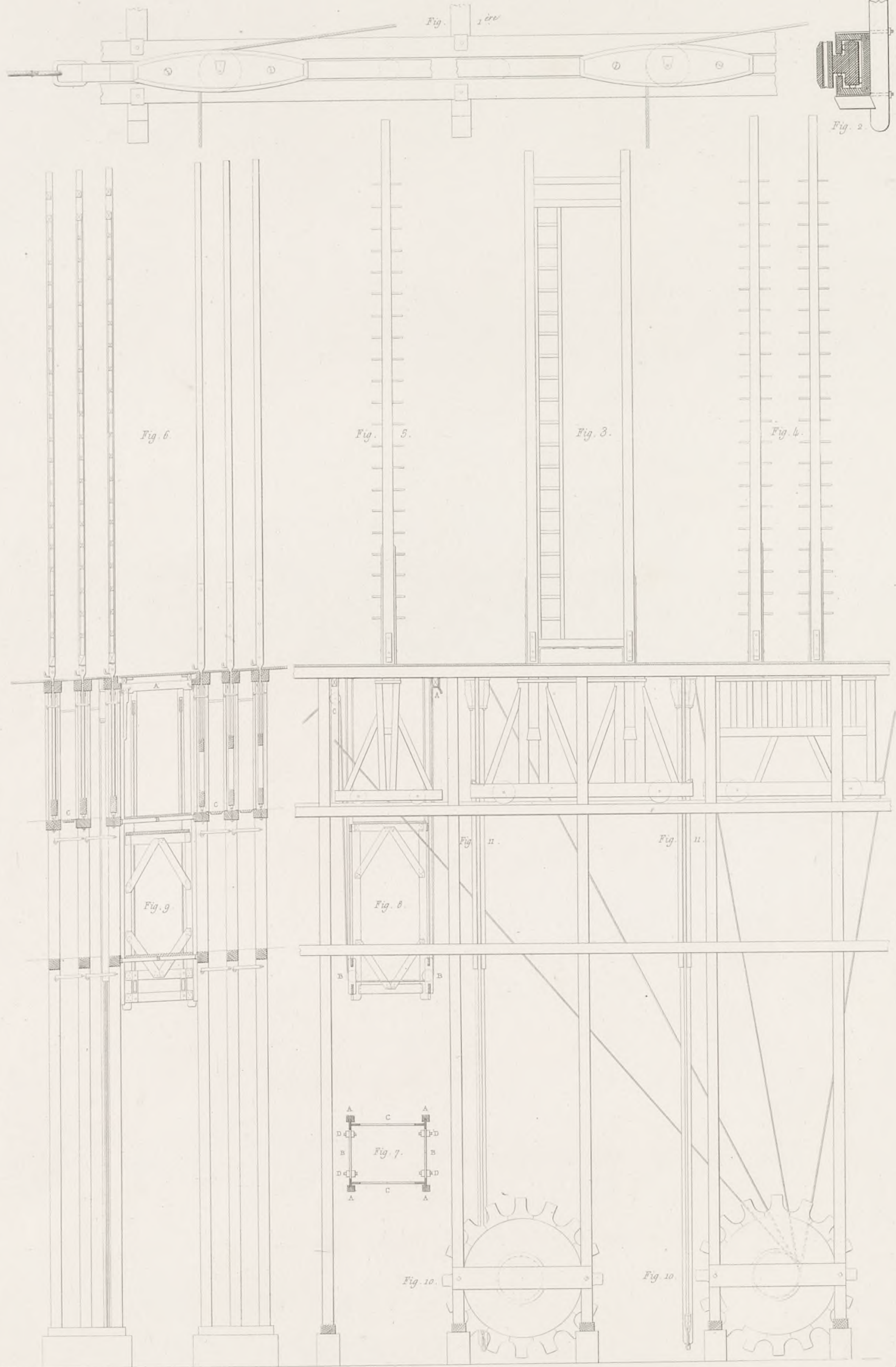

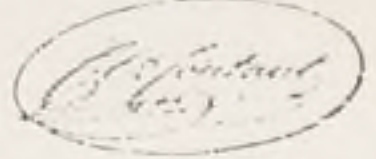

COUPE TRANSVERSALE, EQUIPE D'UN VOL TOURNANT, DES TRAPILLONS ET DES CHASSIS ET FERMES
(SYSTEME ANGLAIS)

Pl 1^{ere}

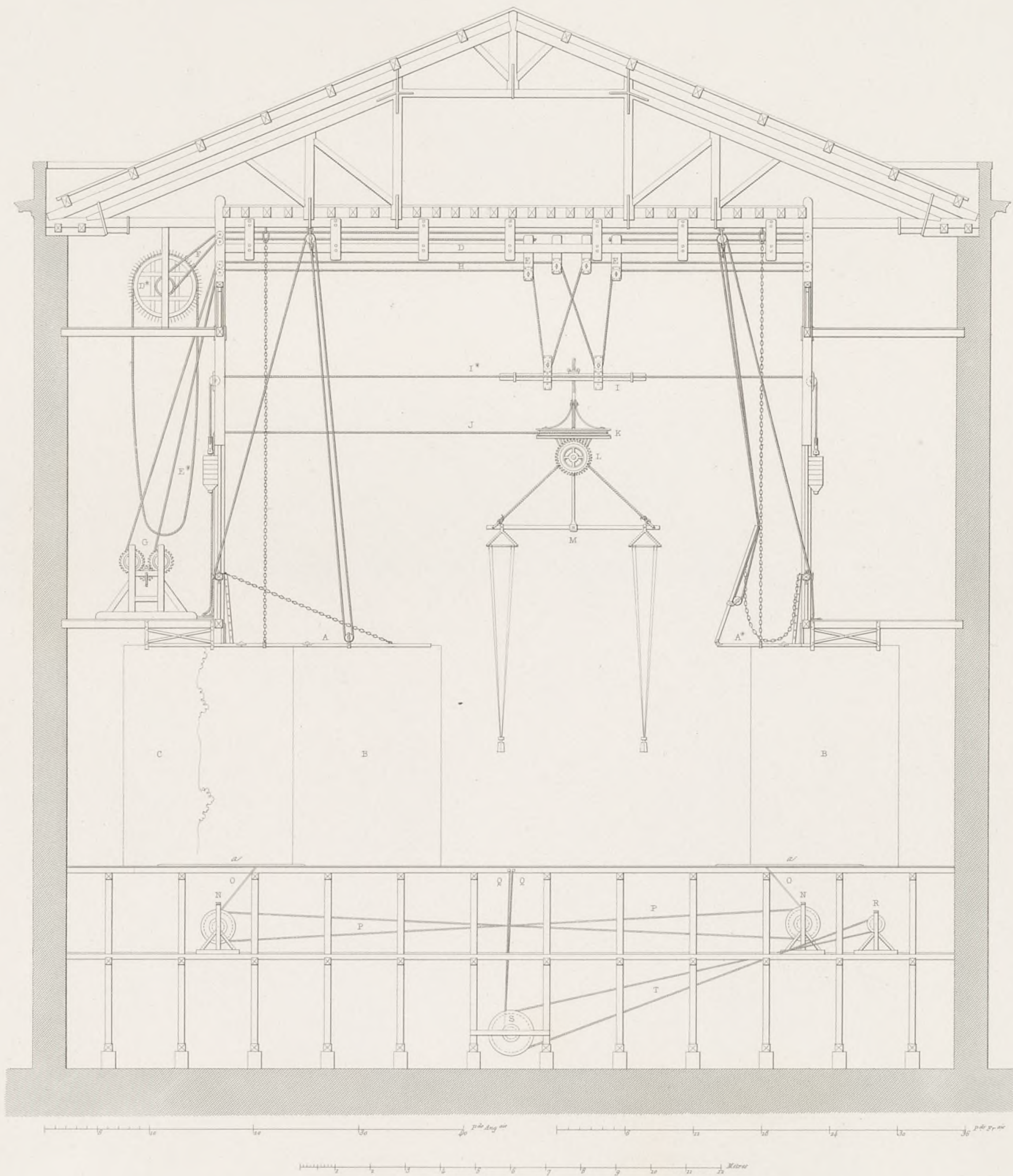

CONDUCTEURS MOBILES DE CHASSIS ET FERMES,
(SYST. ANGLAIS)

Pl. 2.

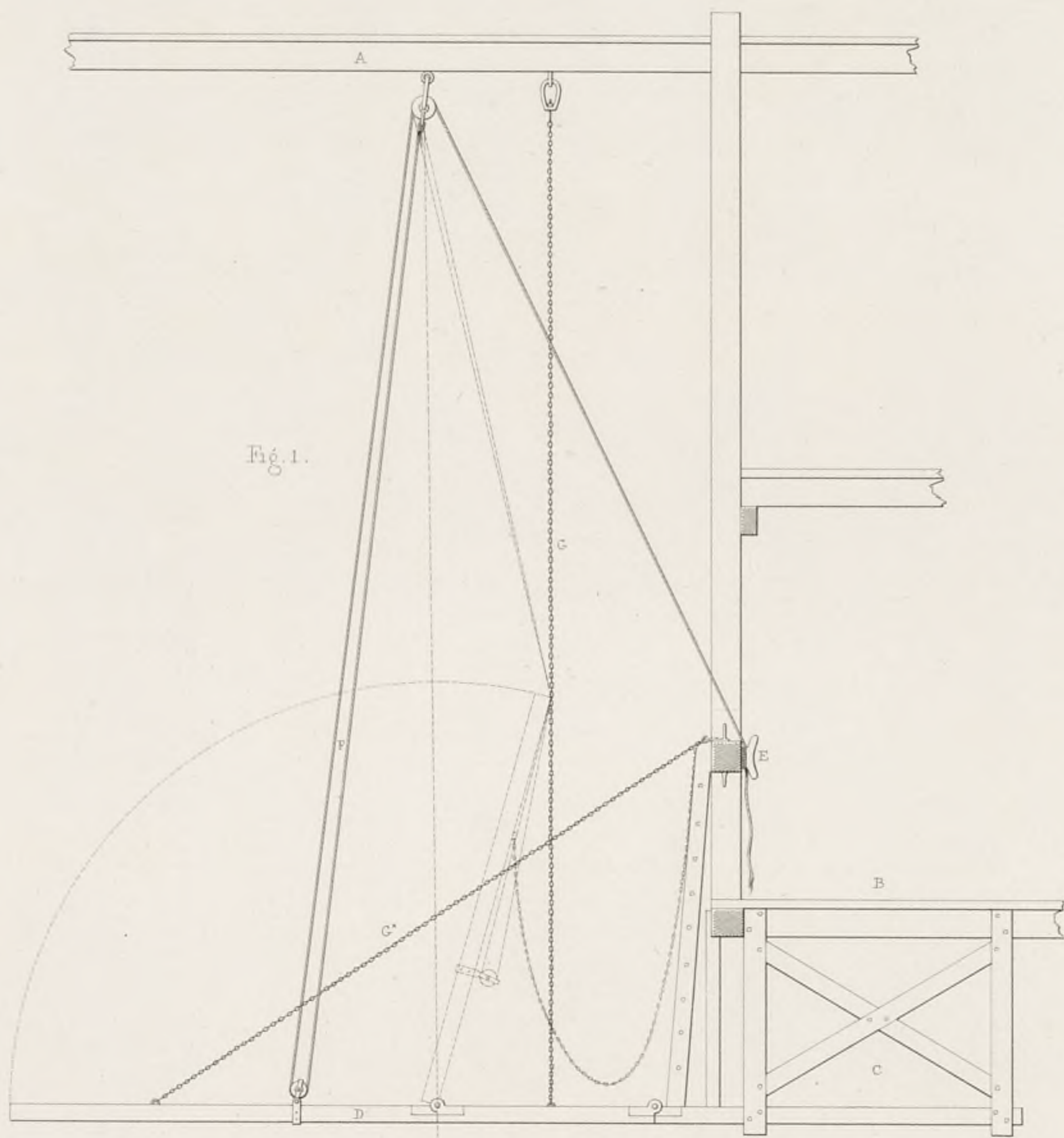

Fig. 1.

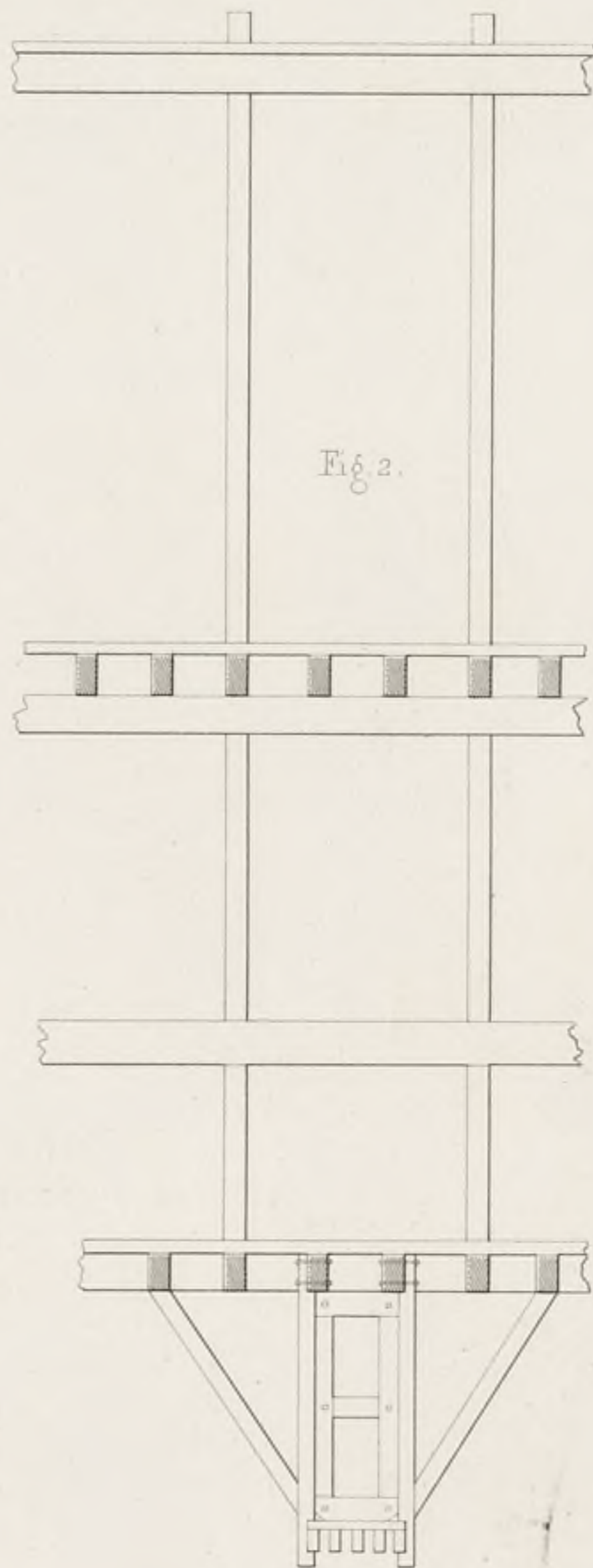

Fig. 2.

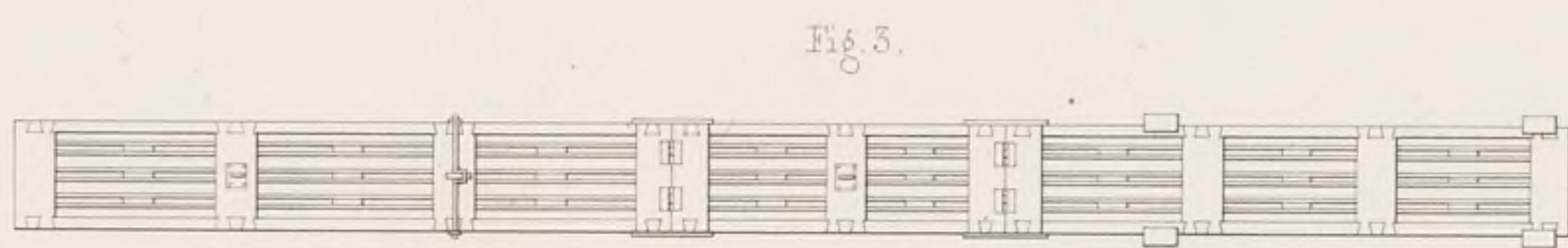

Fig. 3.

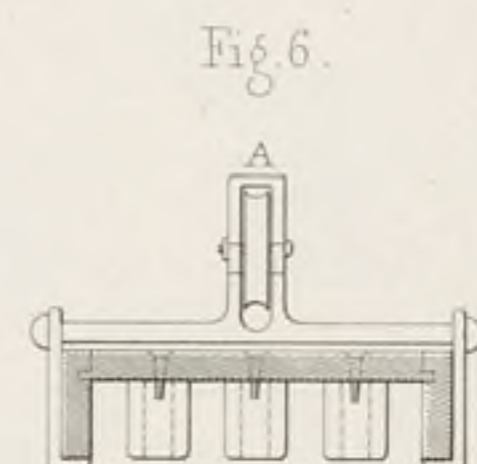

Fig. 6.

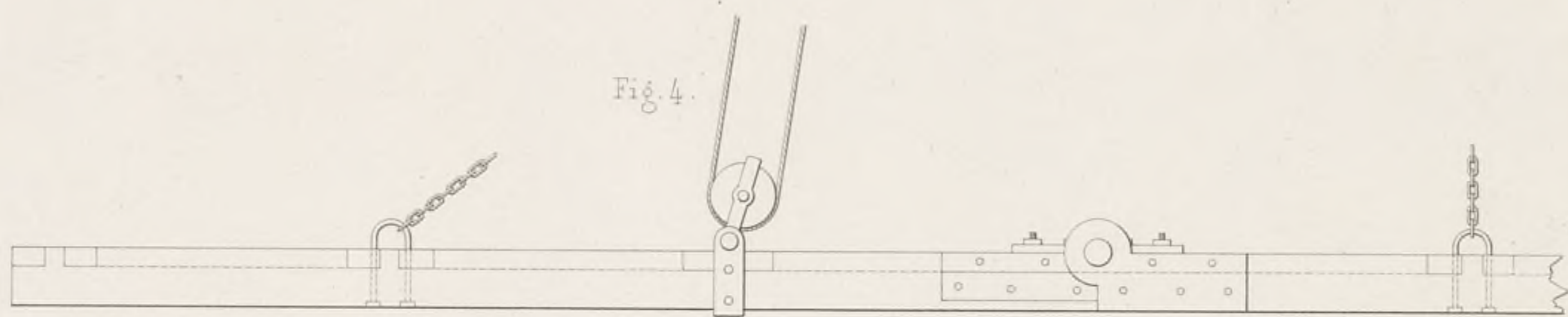

Fig. 4.

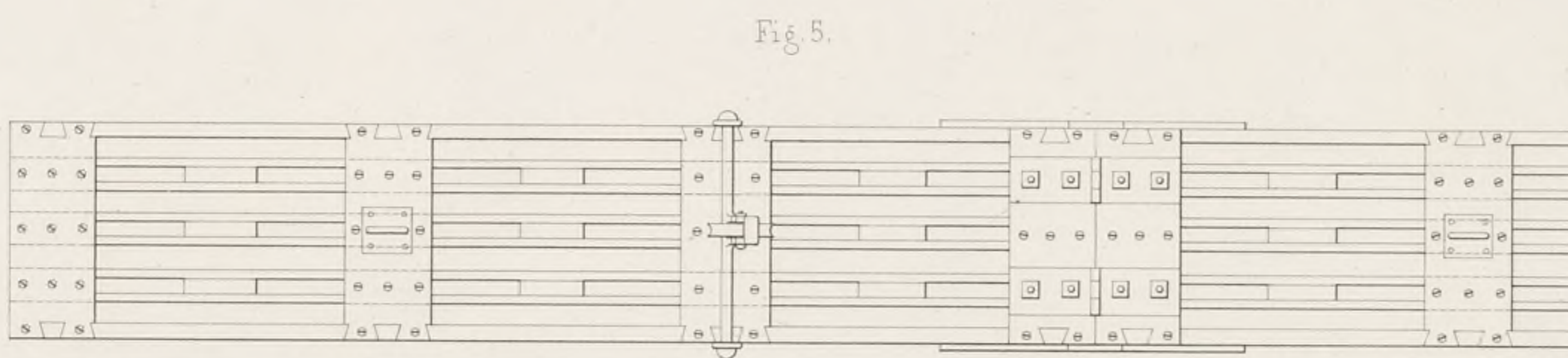
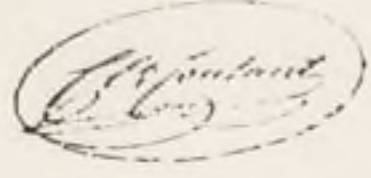
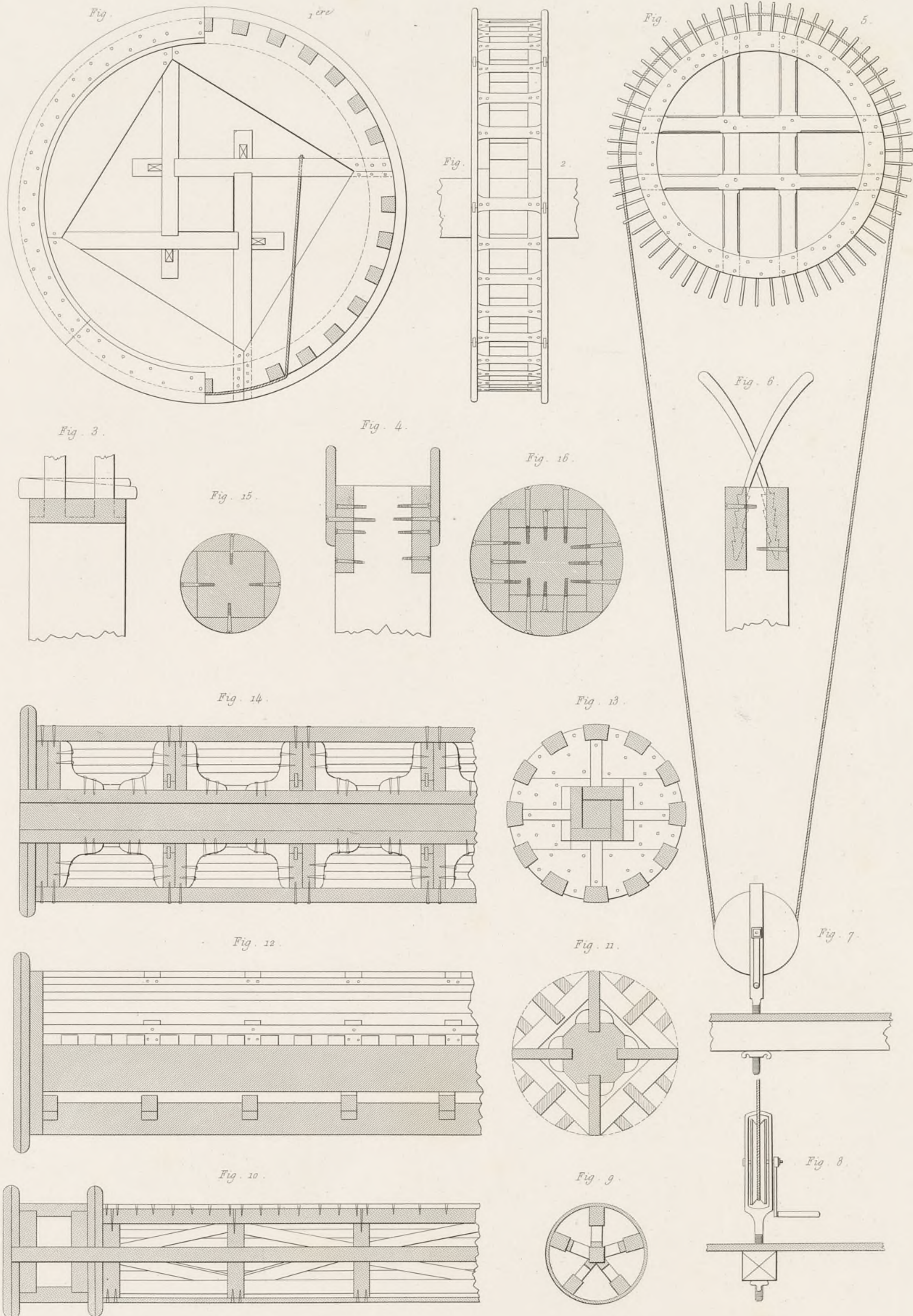
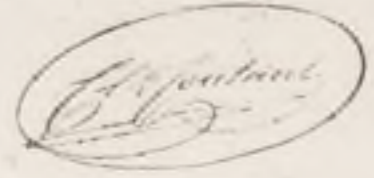

Fig. 5.



CONSTRUCTION DES TAMBOURS.
(SYSTEME ANGLAIS)





CONSTRUCTION DES TAMBOURS.
(SYST. ANGLAIS)

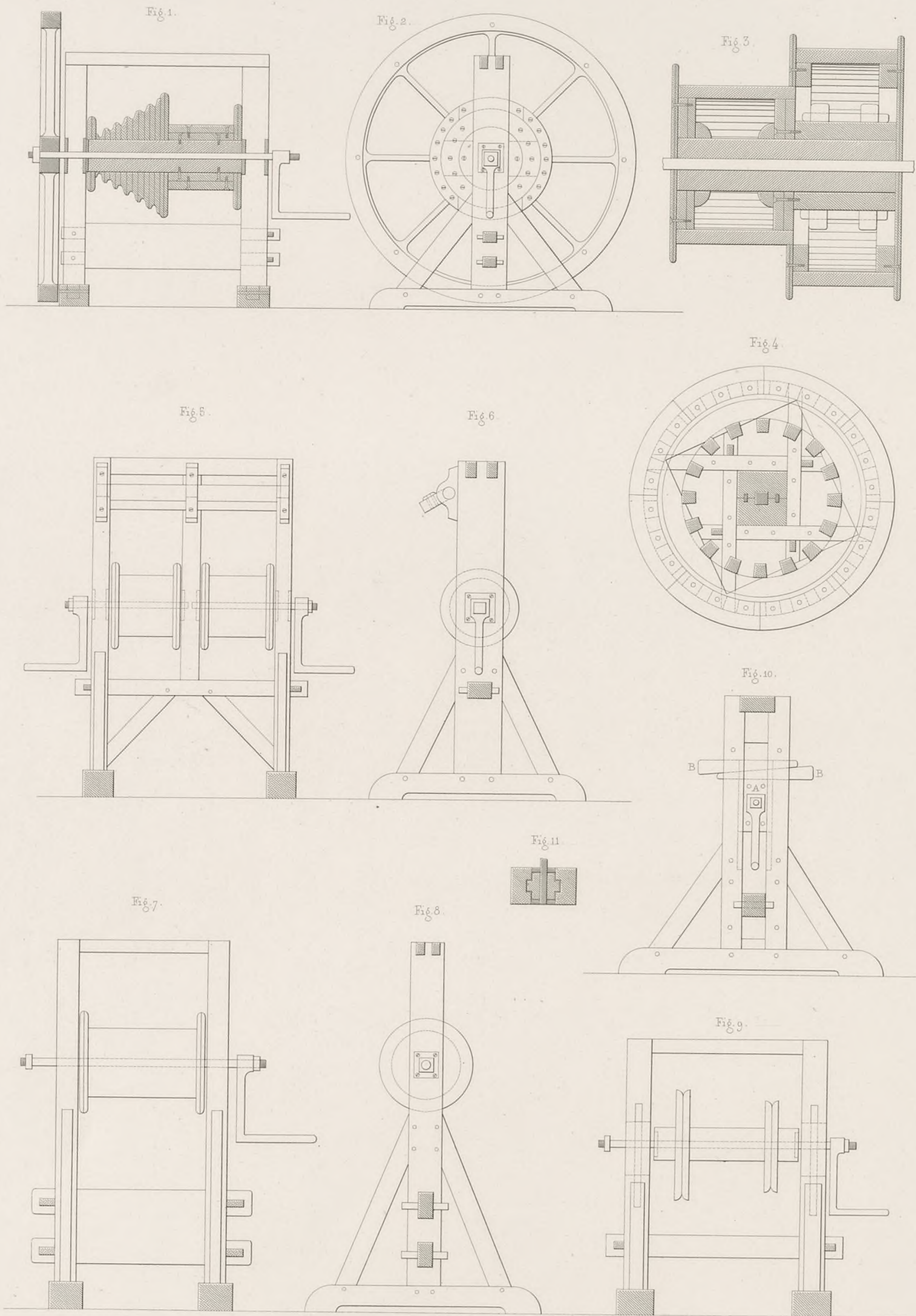

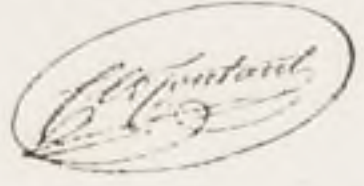

EQUIPE DES TRAPPES
(SYST. ANGLAIS.)

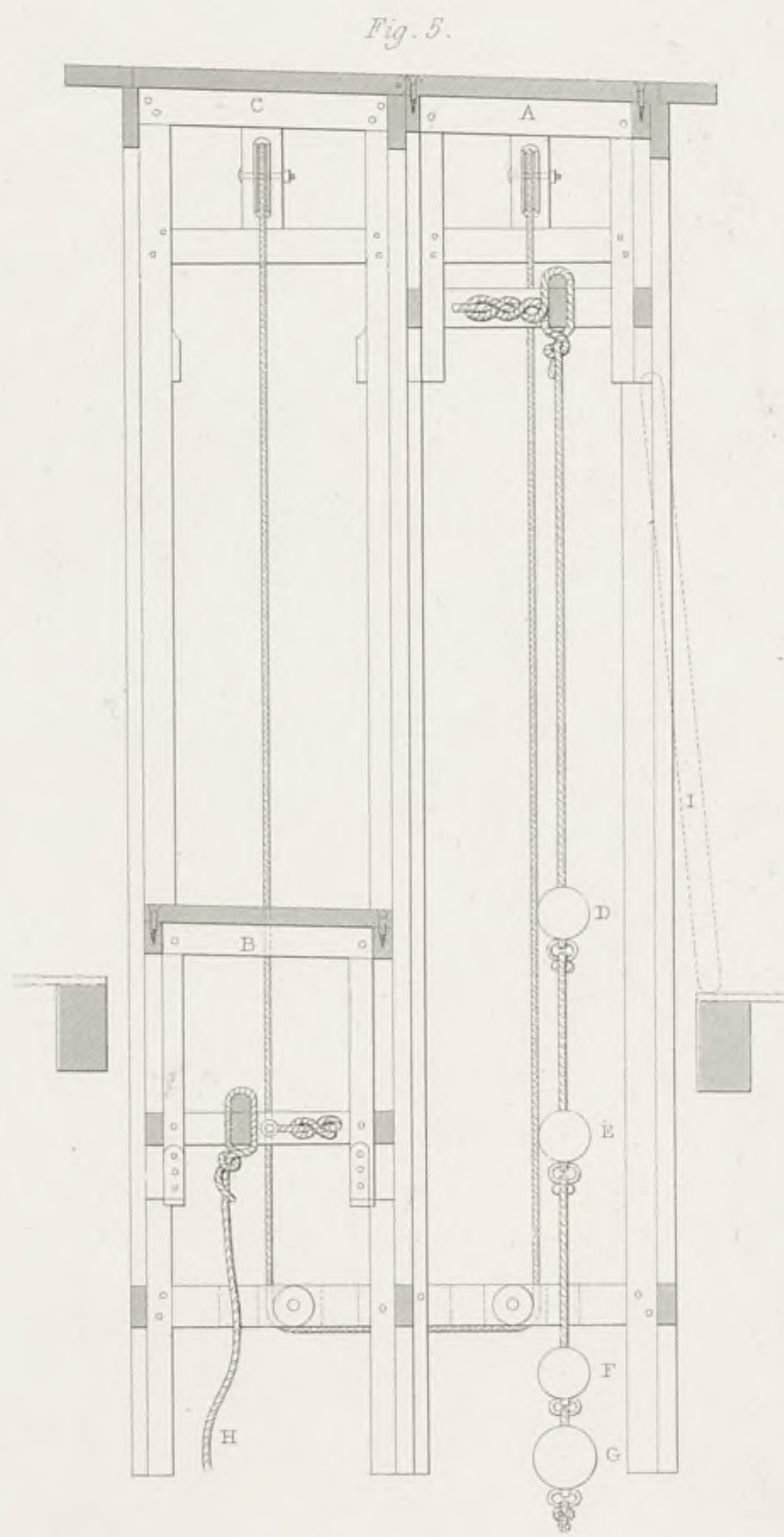
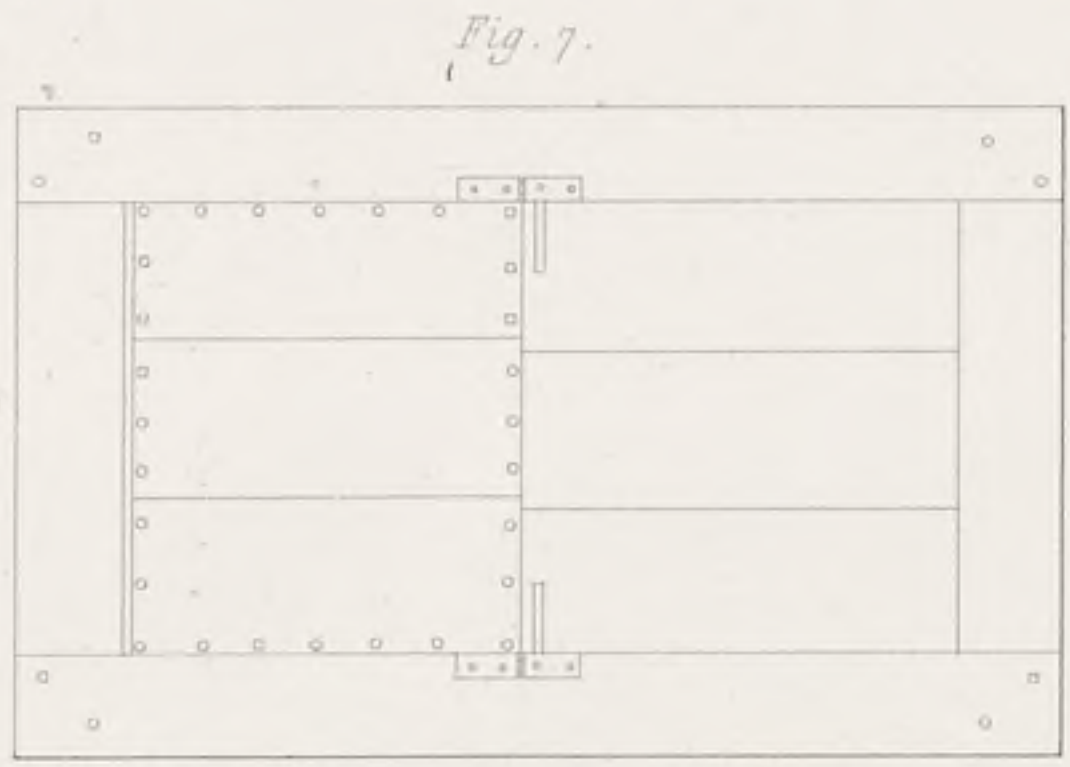
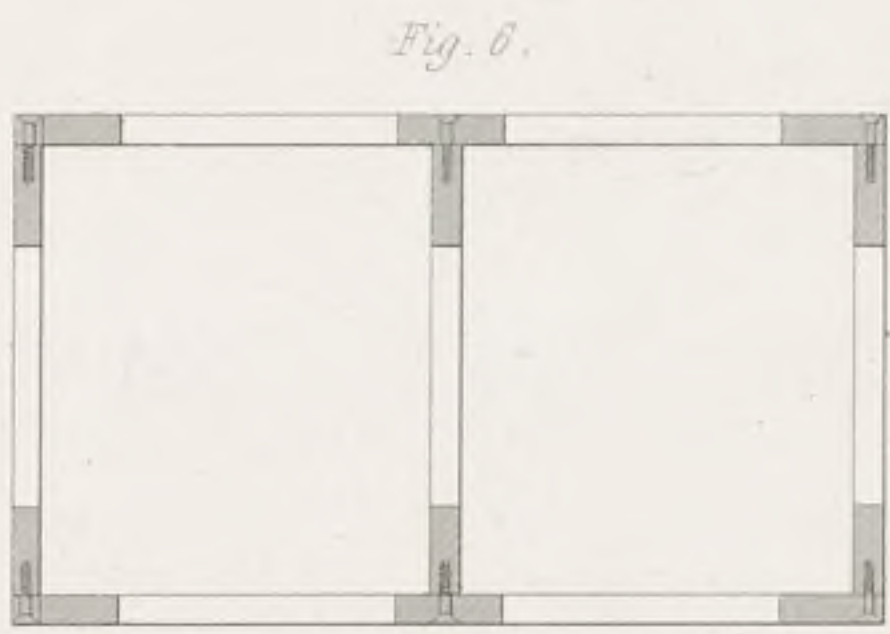
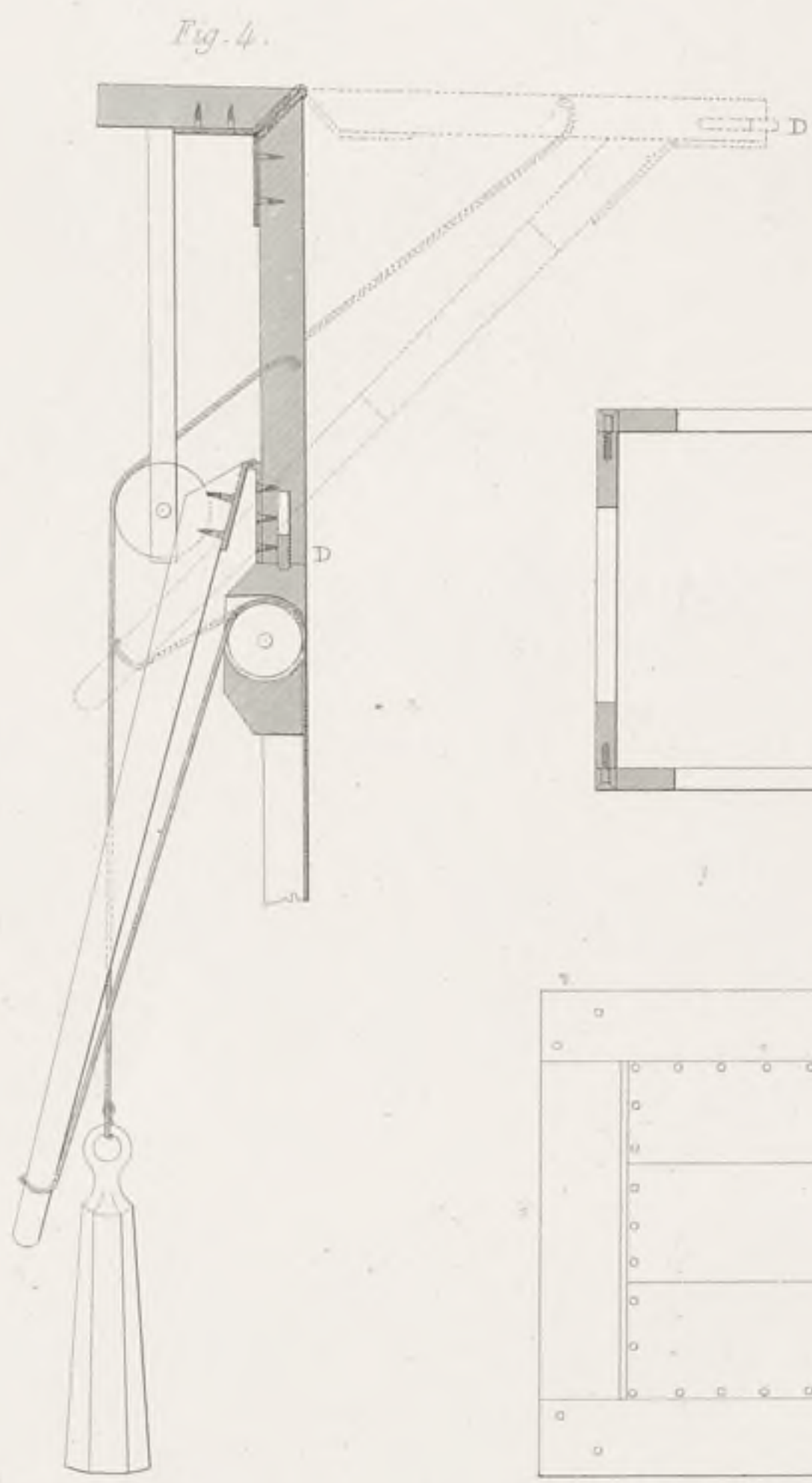
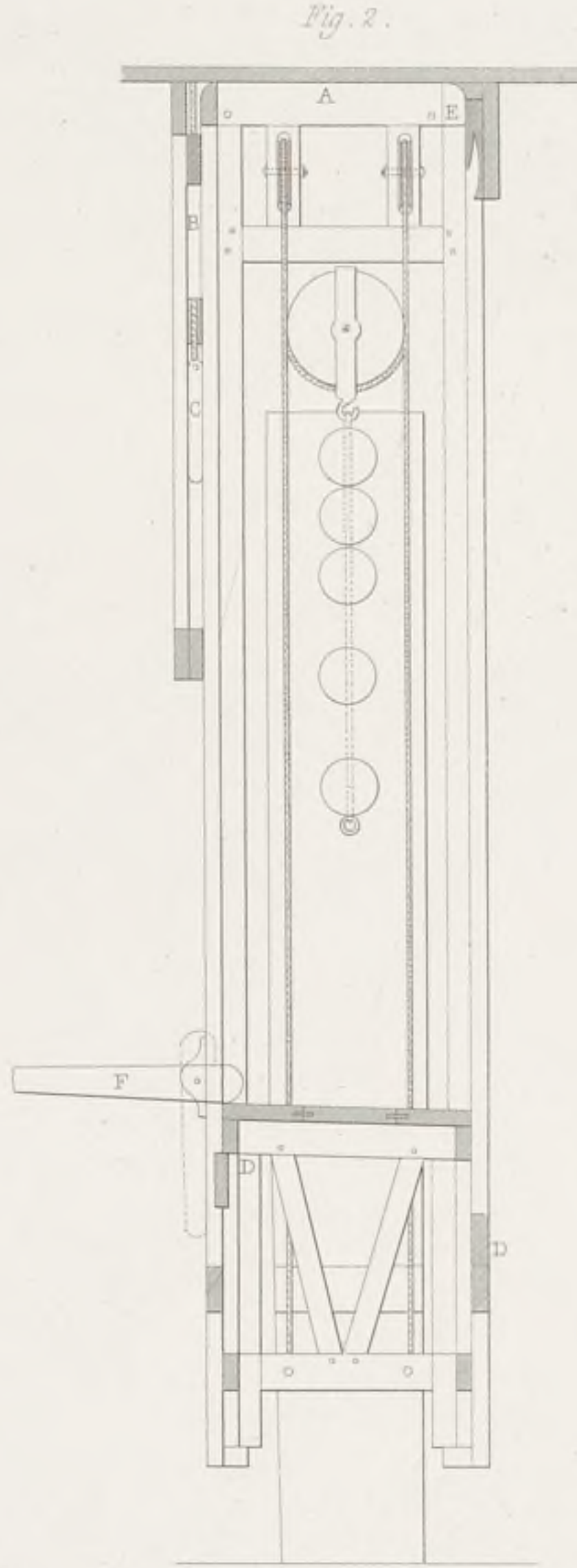
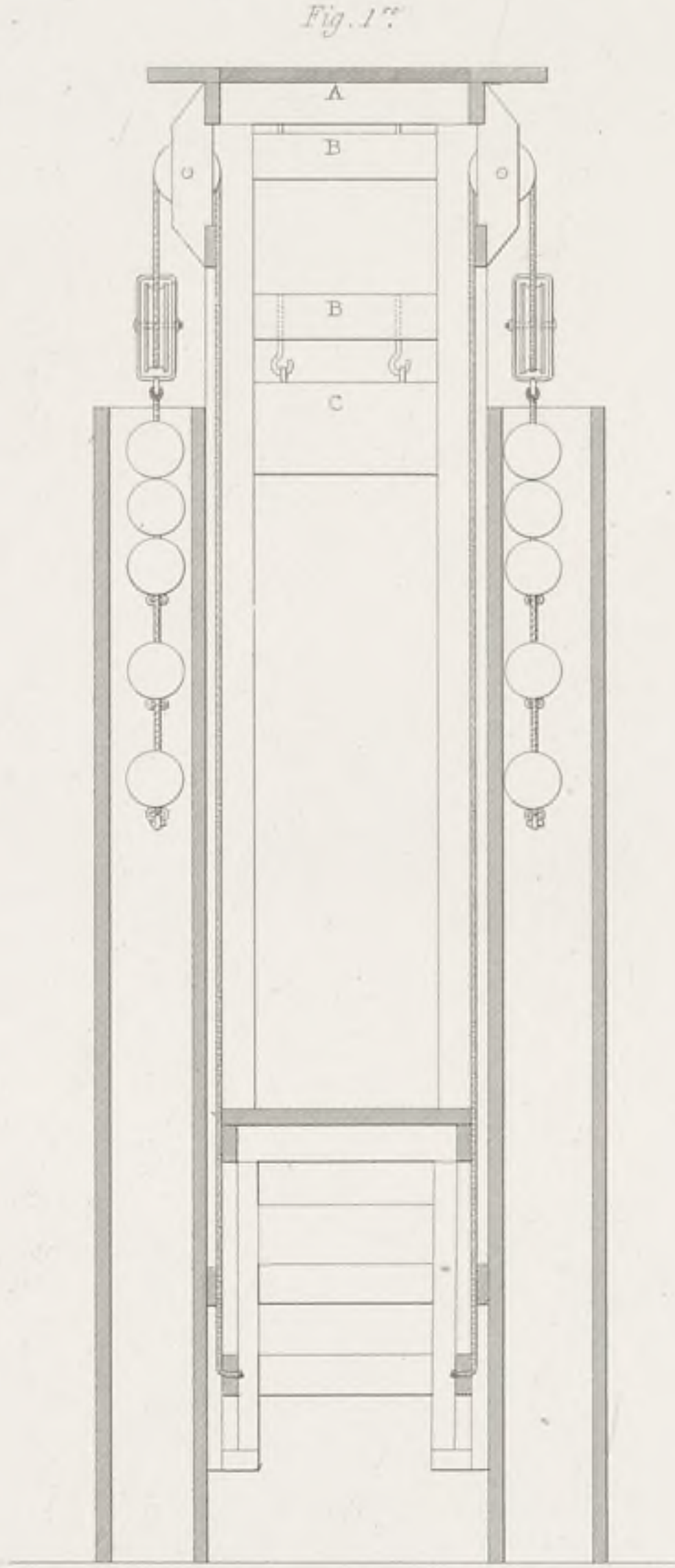
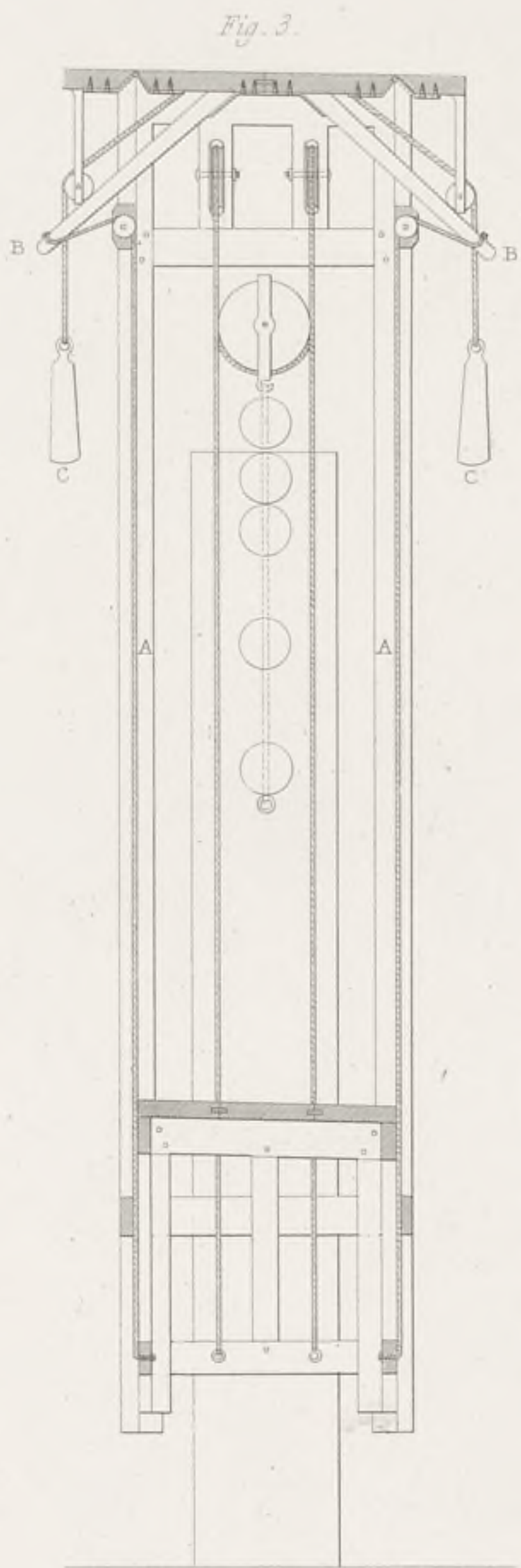

EQUIPE DES TRAPPES,
(SYST. ANGLAIS.)

Pl. 6.

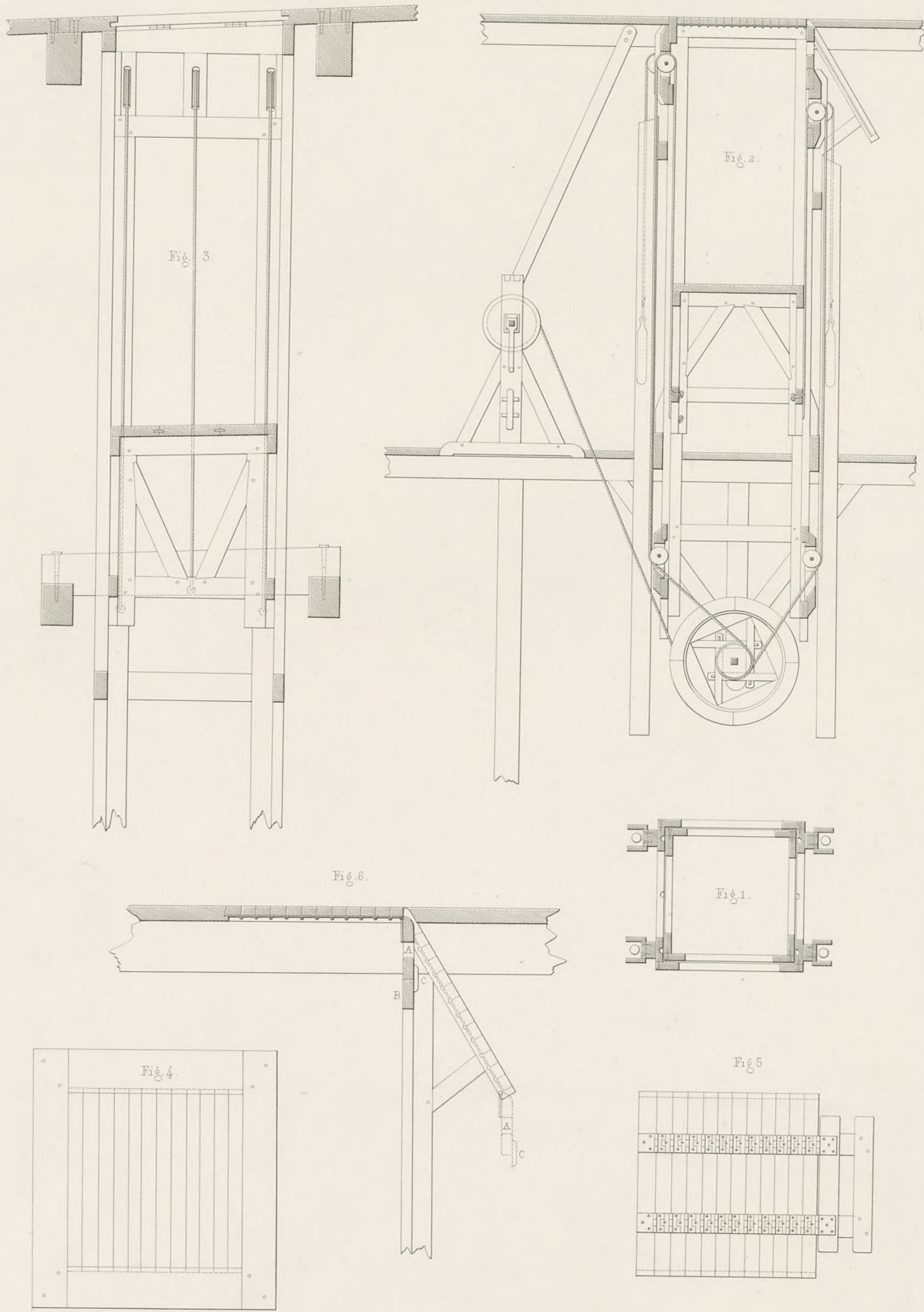

C. Contant, del.

J. Petitecollin, Sculp.

Contant

EQUIPE DES TRAPPES
(SYST. ANGLAIS.)

Pl. 7

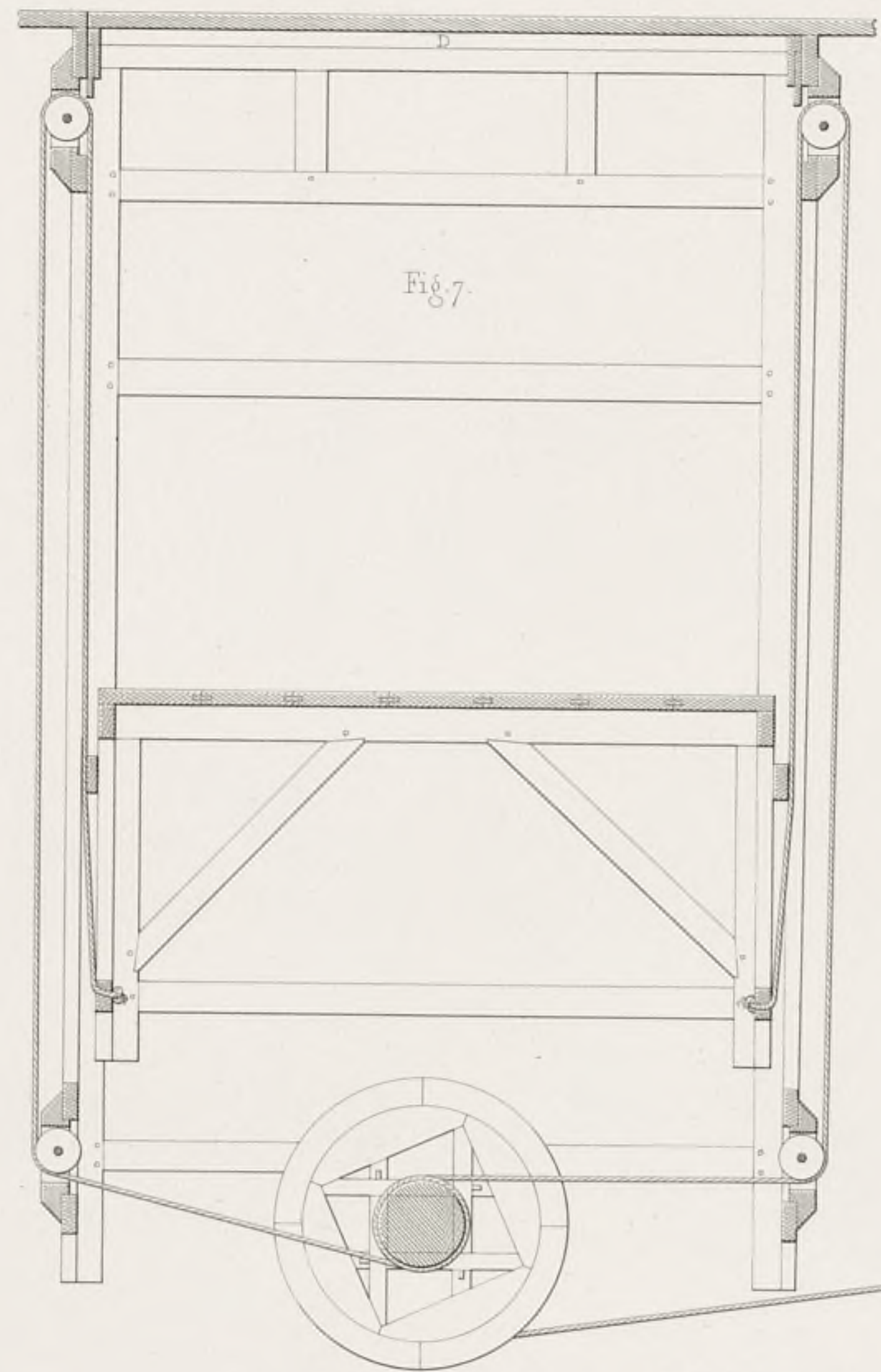
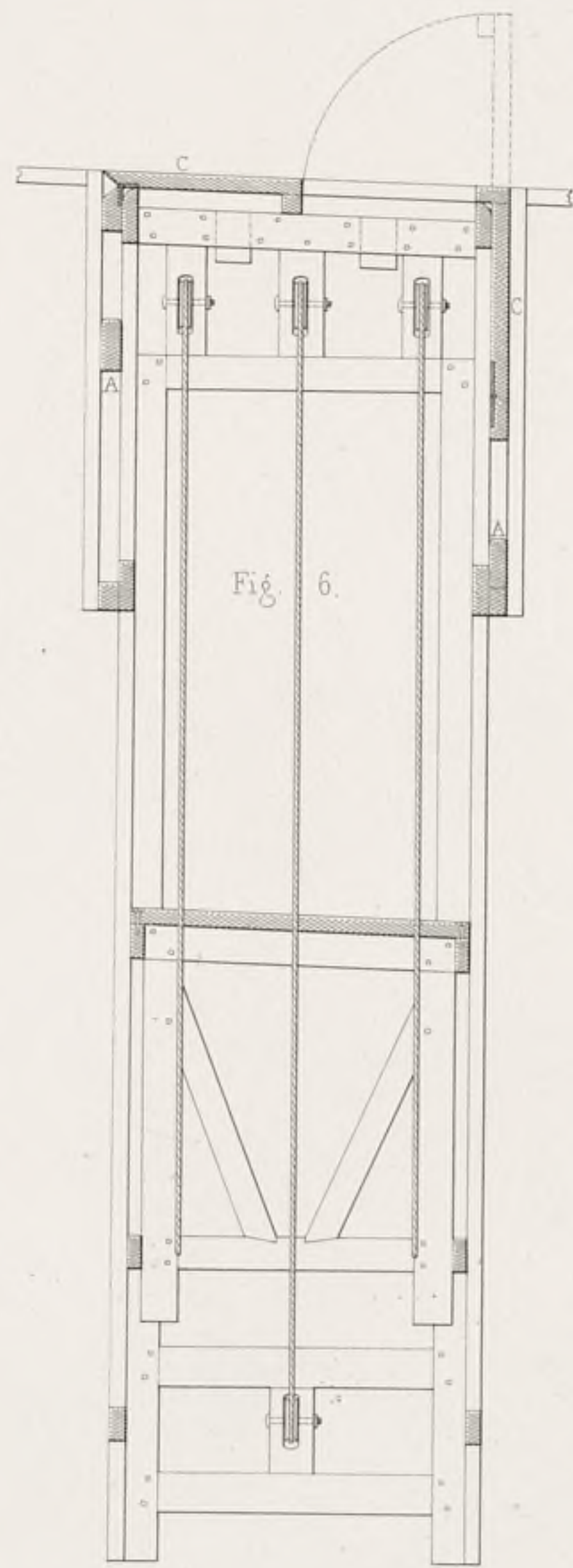
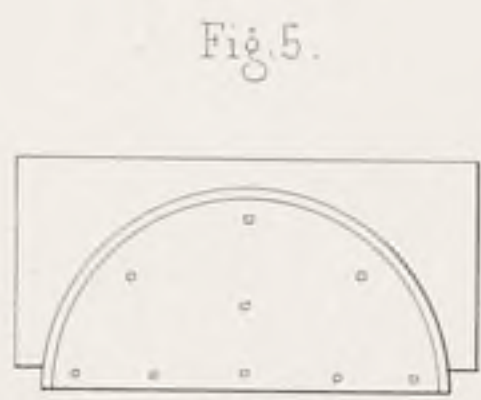
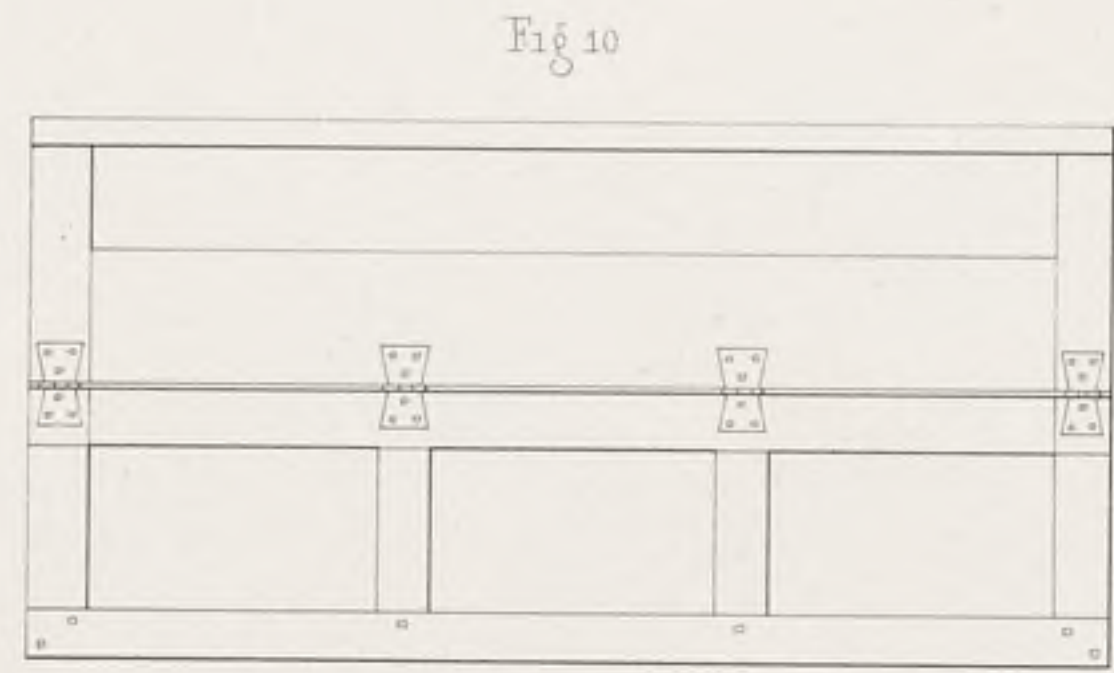
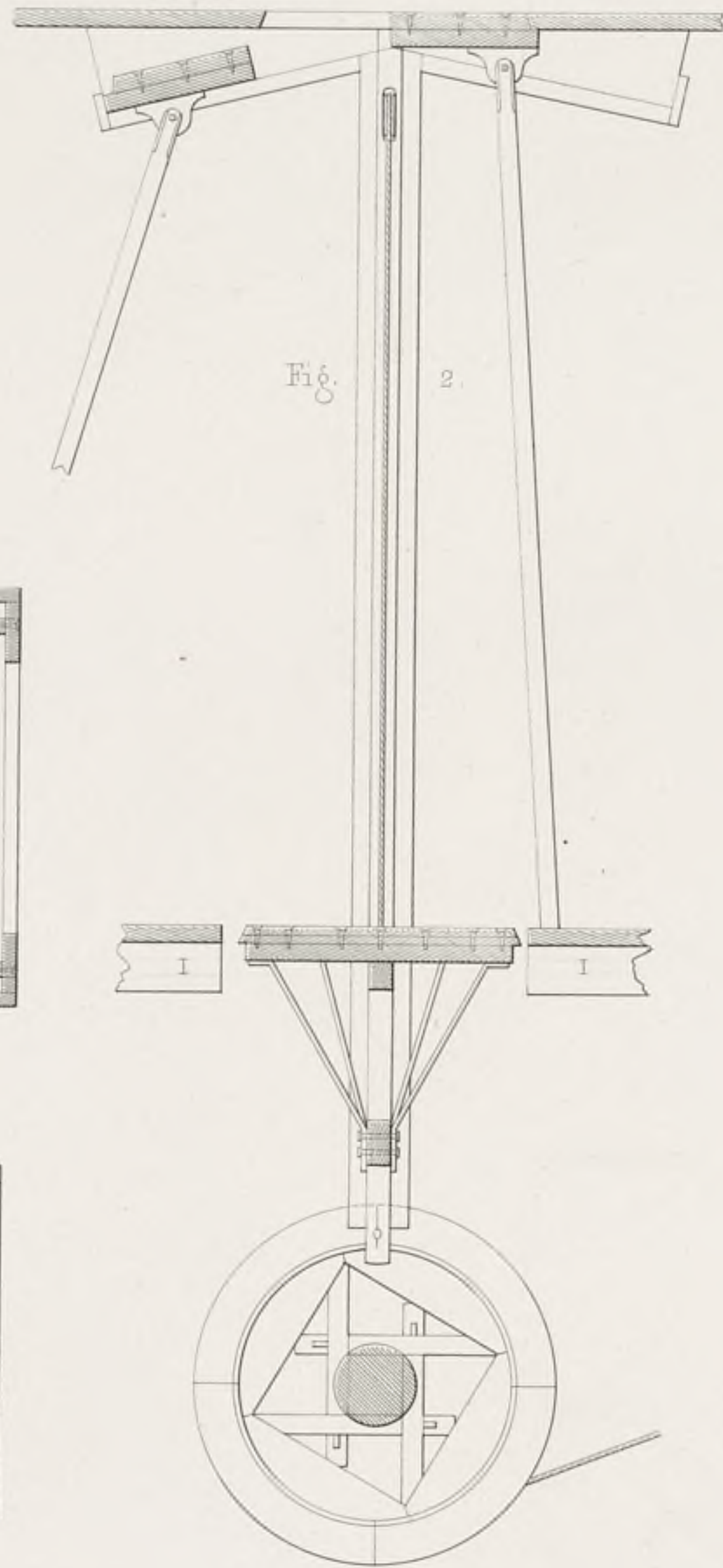
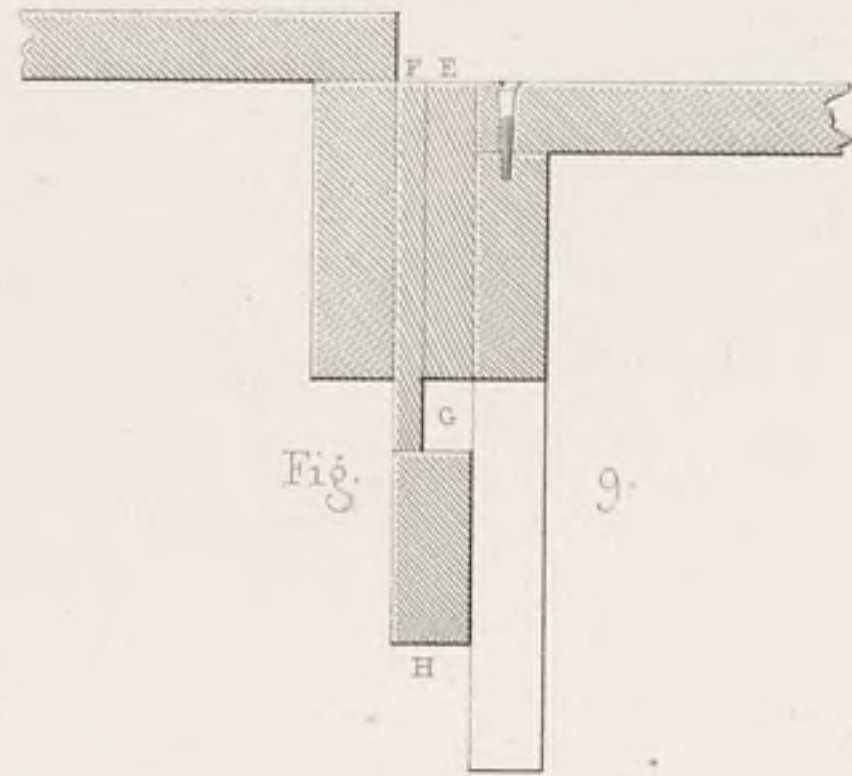
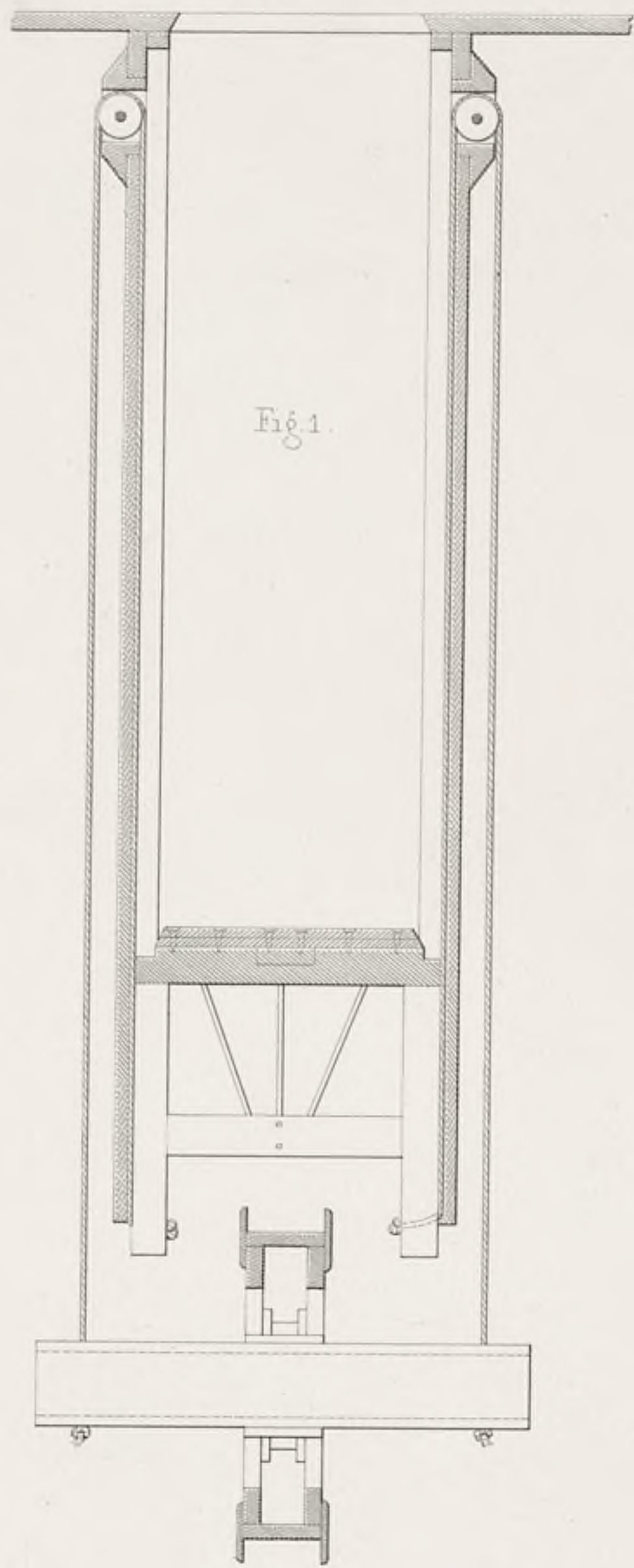

C. Contant, del.

J. Petitcolin, Sculp.

Contant

IMITATION DES ECLATS DU TONNERRE,
(SYST ANGLAIS.)

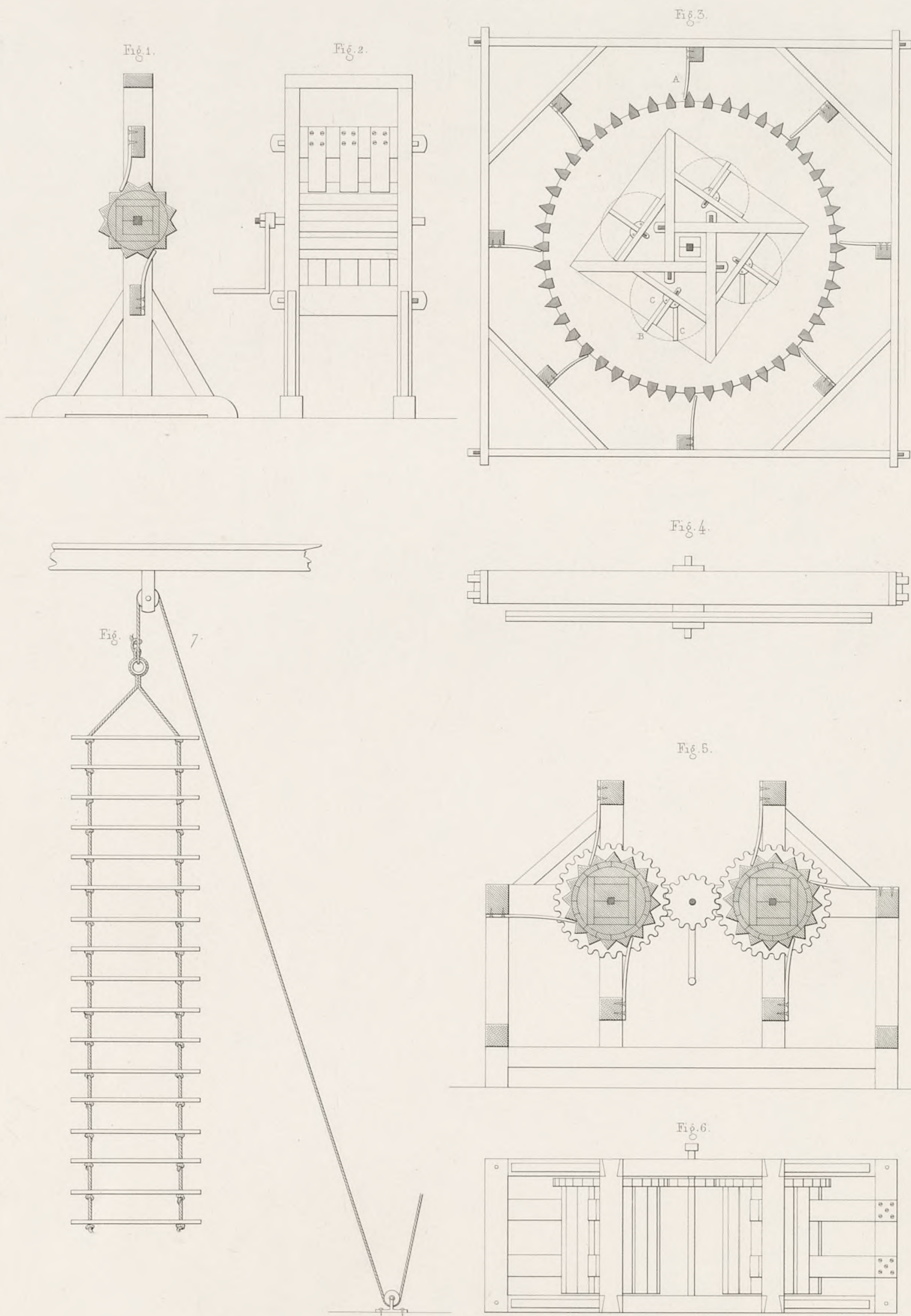

C. Contant del.

J. Petitcolin, Sculp.



IMITATION DU VENT ET PARALLELE EN FER.
(SYST ANGLAIS)

Pl. 9.

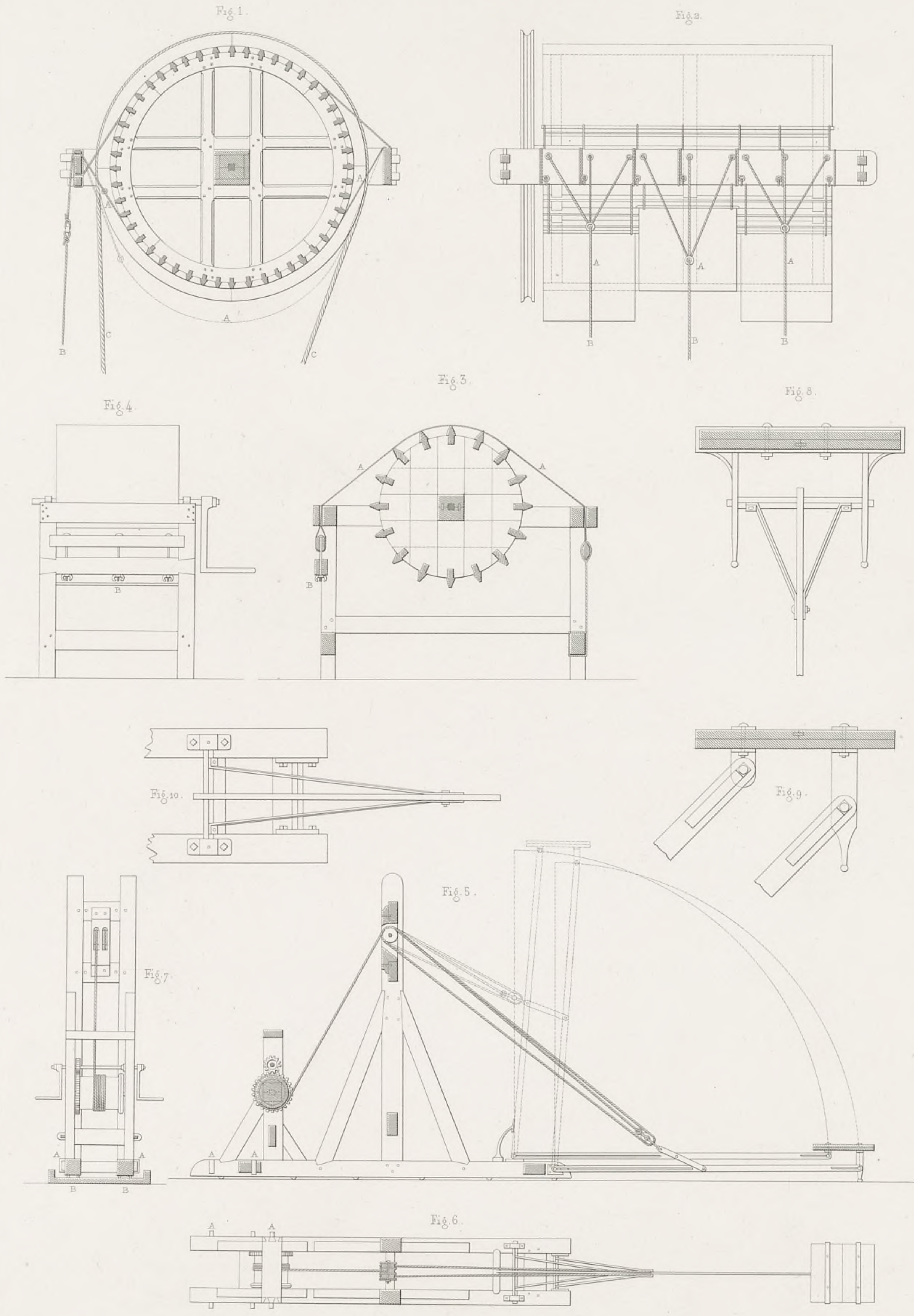

C. Contant del.

J. Petitcolin Sculp.

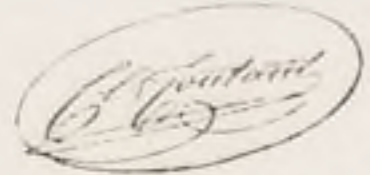

CONSTRUCTION DES CASSETTES ET TREUILS POUR VOLS.
(SYST. ANGLAIS.)

Pl. 10.

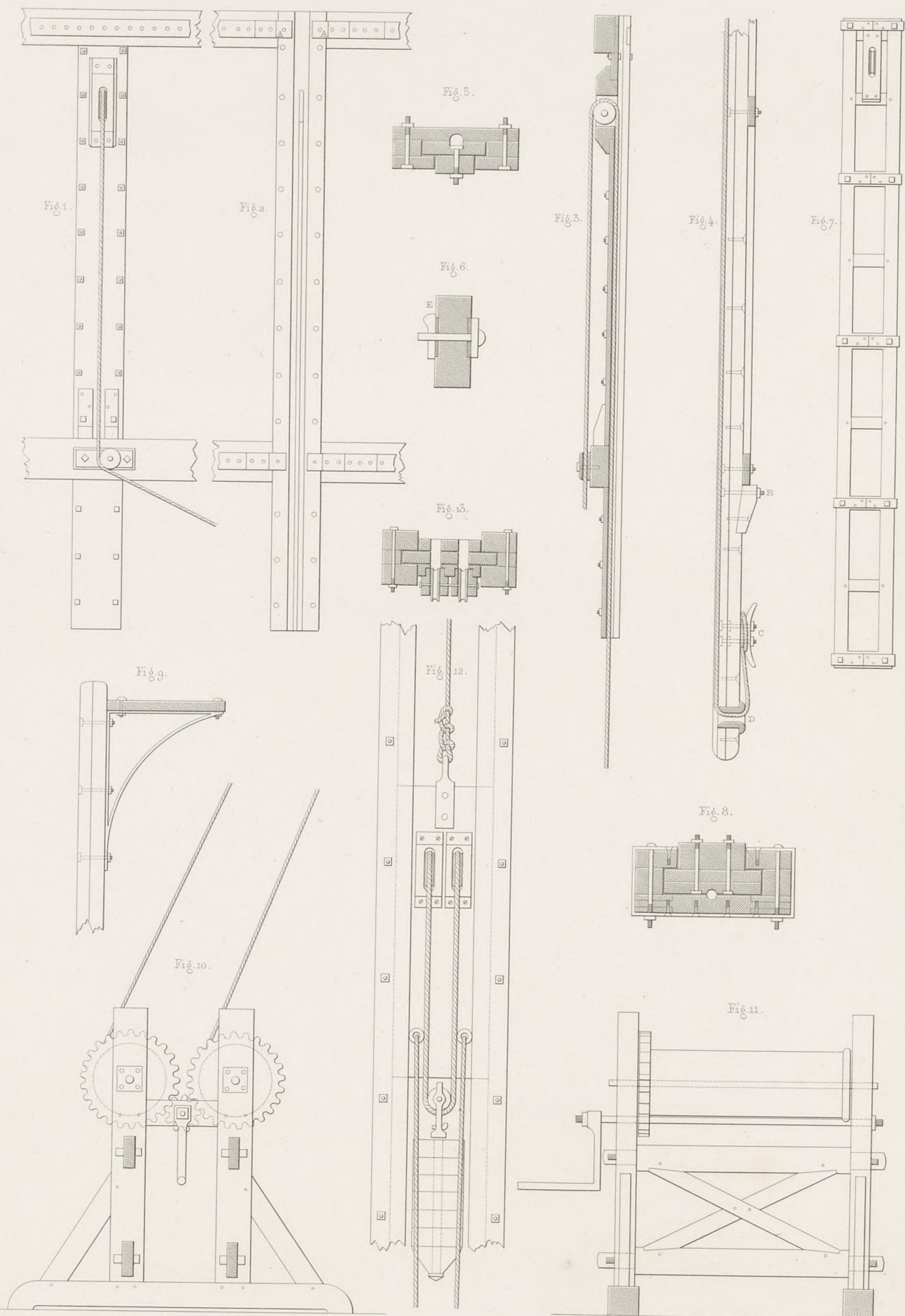

C. Contant, del.

J. Petitcollin, Sculp.

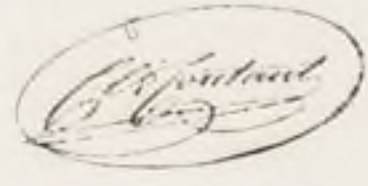

RAMPES DE GAZ ET D'ARTIFICES.
(SYST. ANGLAIS.)

Pl. 11.

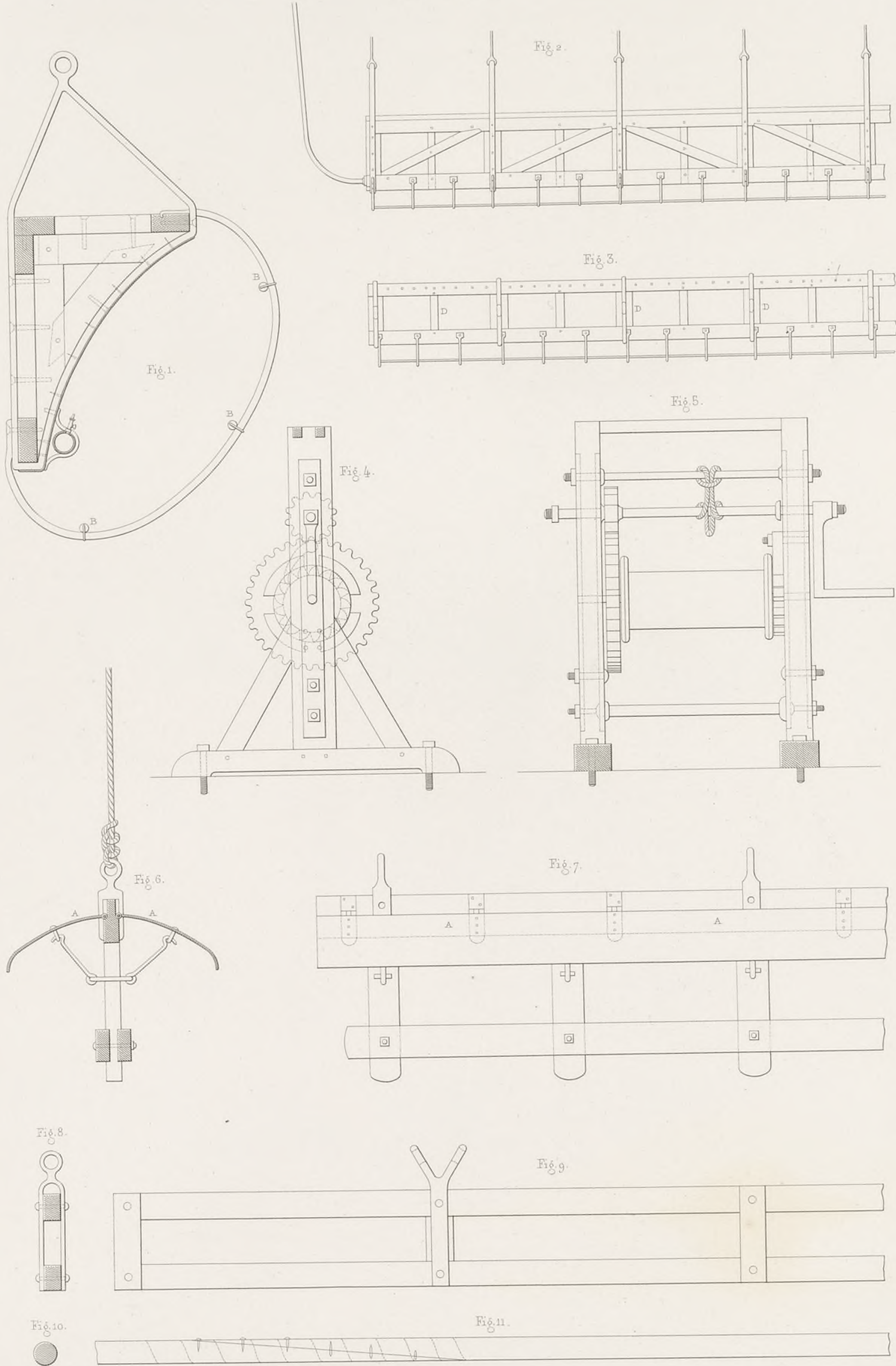

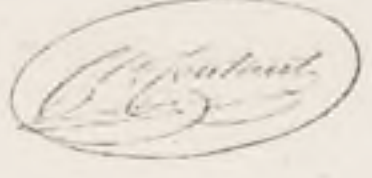

PLANCHERS DE GLOIRES,
(SYST. ANGLAIS.)

Pl. 12.

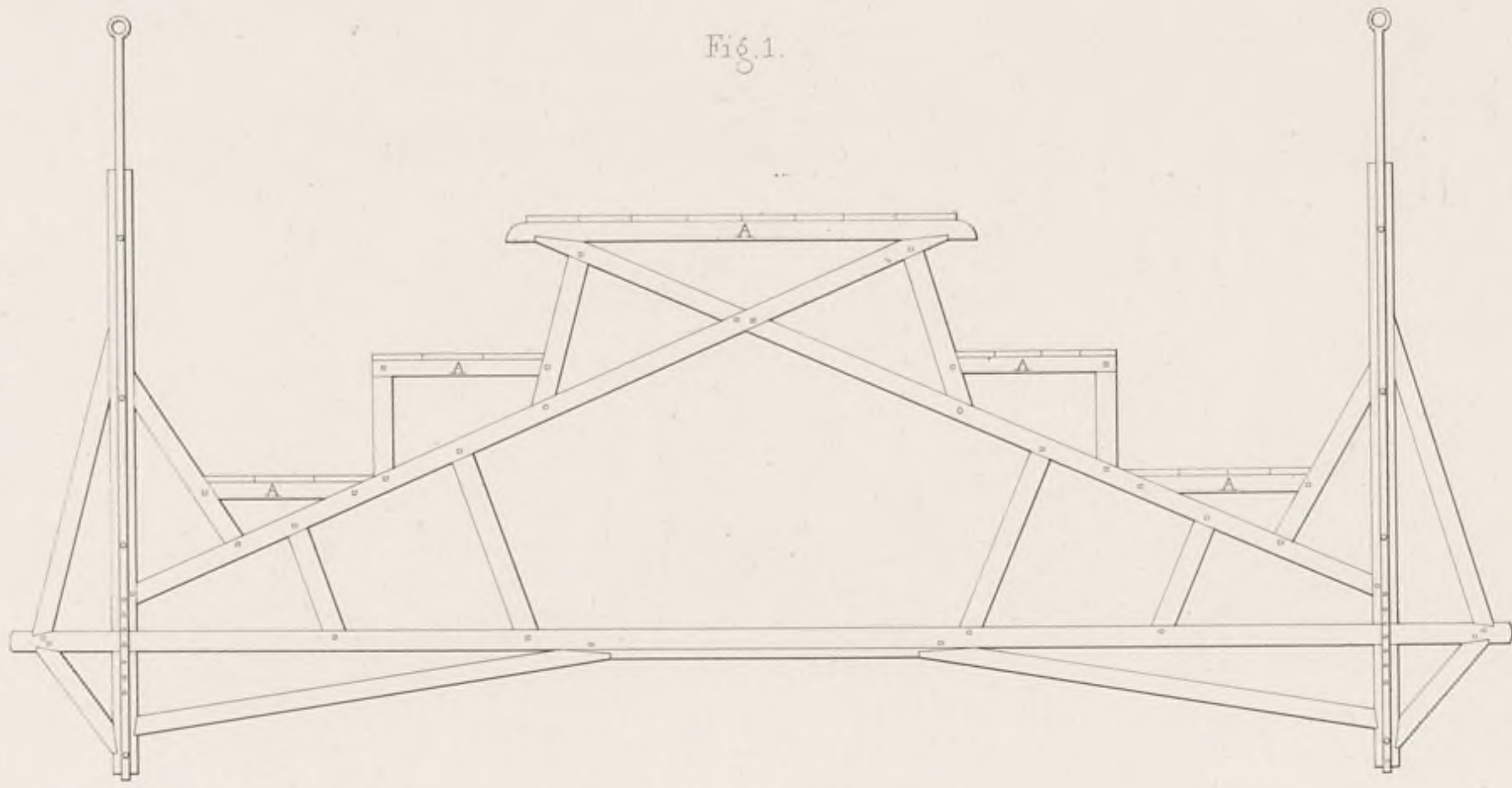

Fig. 1.

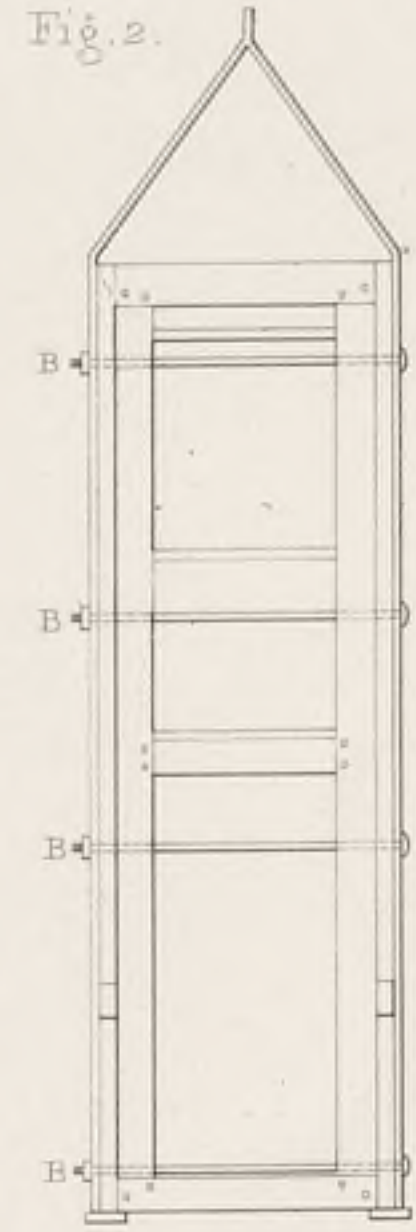

Fig. 2.



Fig. 4.

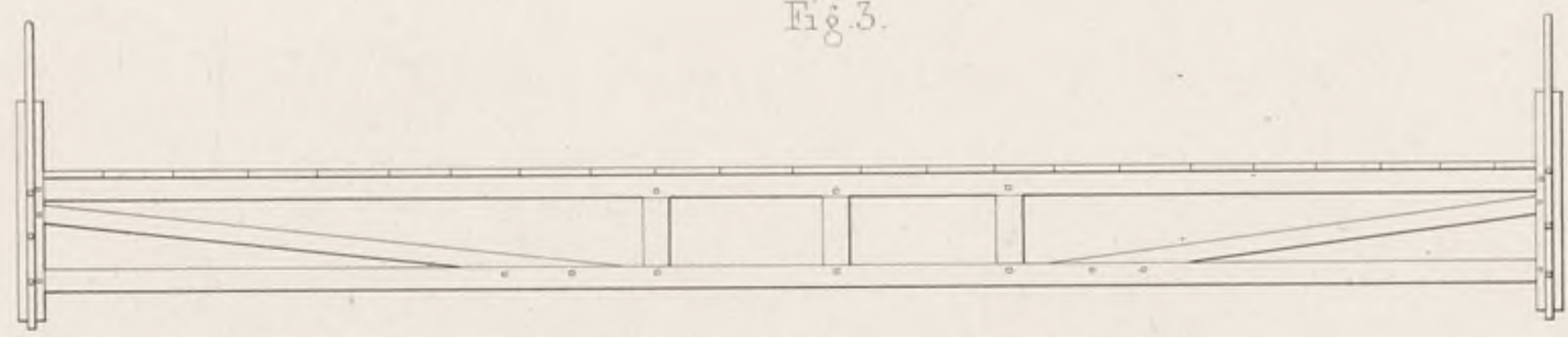

Fig. 3.



Fig. 6.

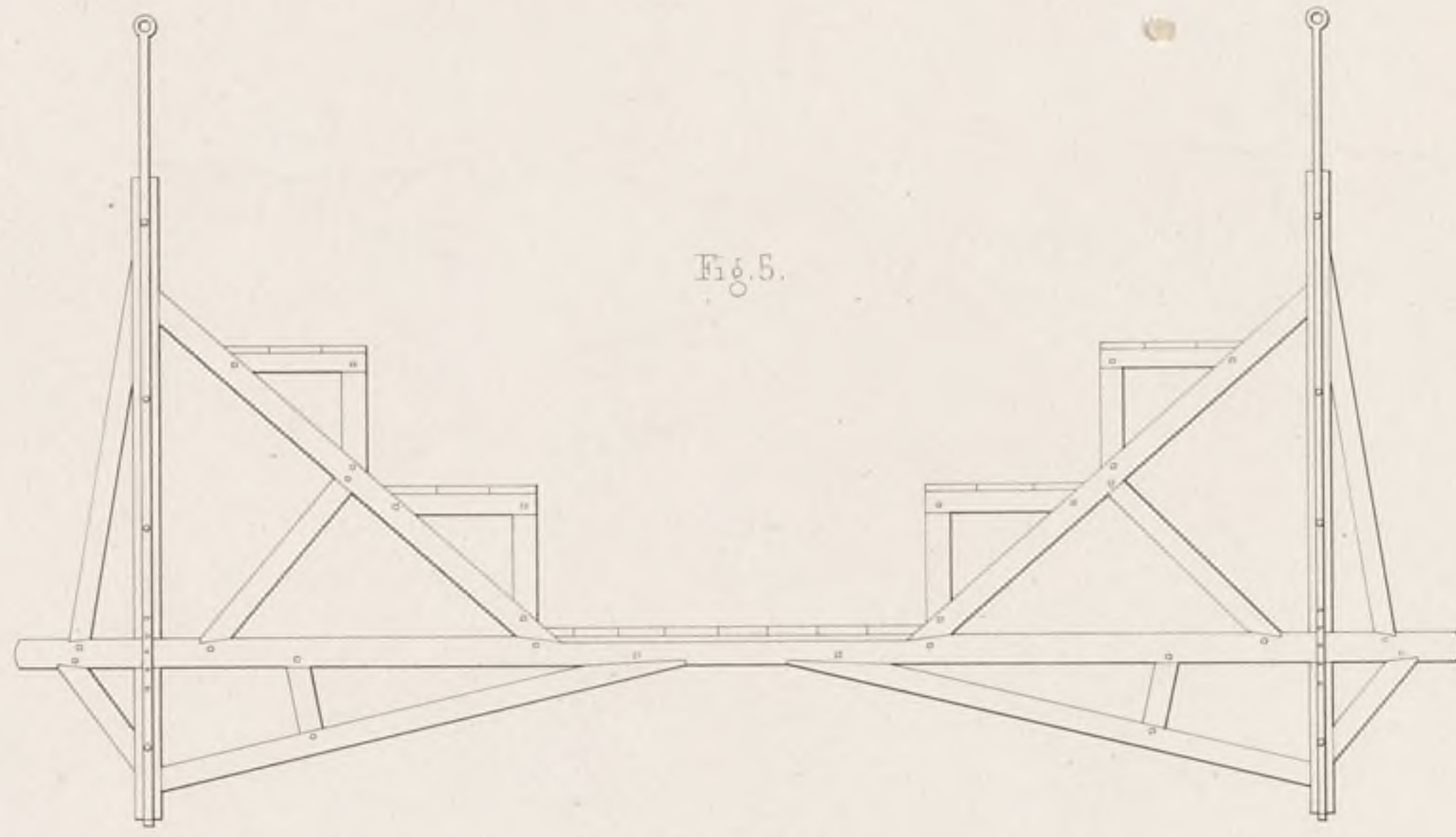

Fig. 5.

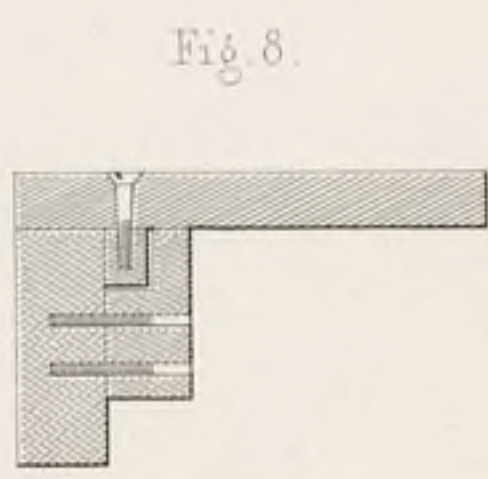

Fig. 8.

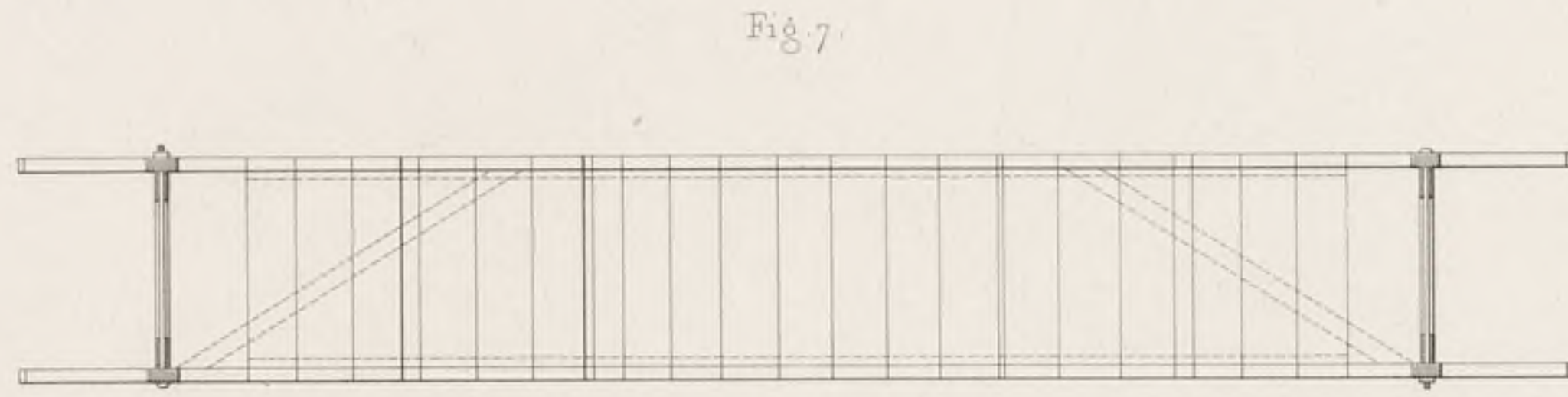

Fig. 7.



EQUIPE DES VOLS,
(SYST. ANGLAIS)

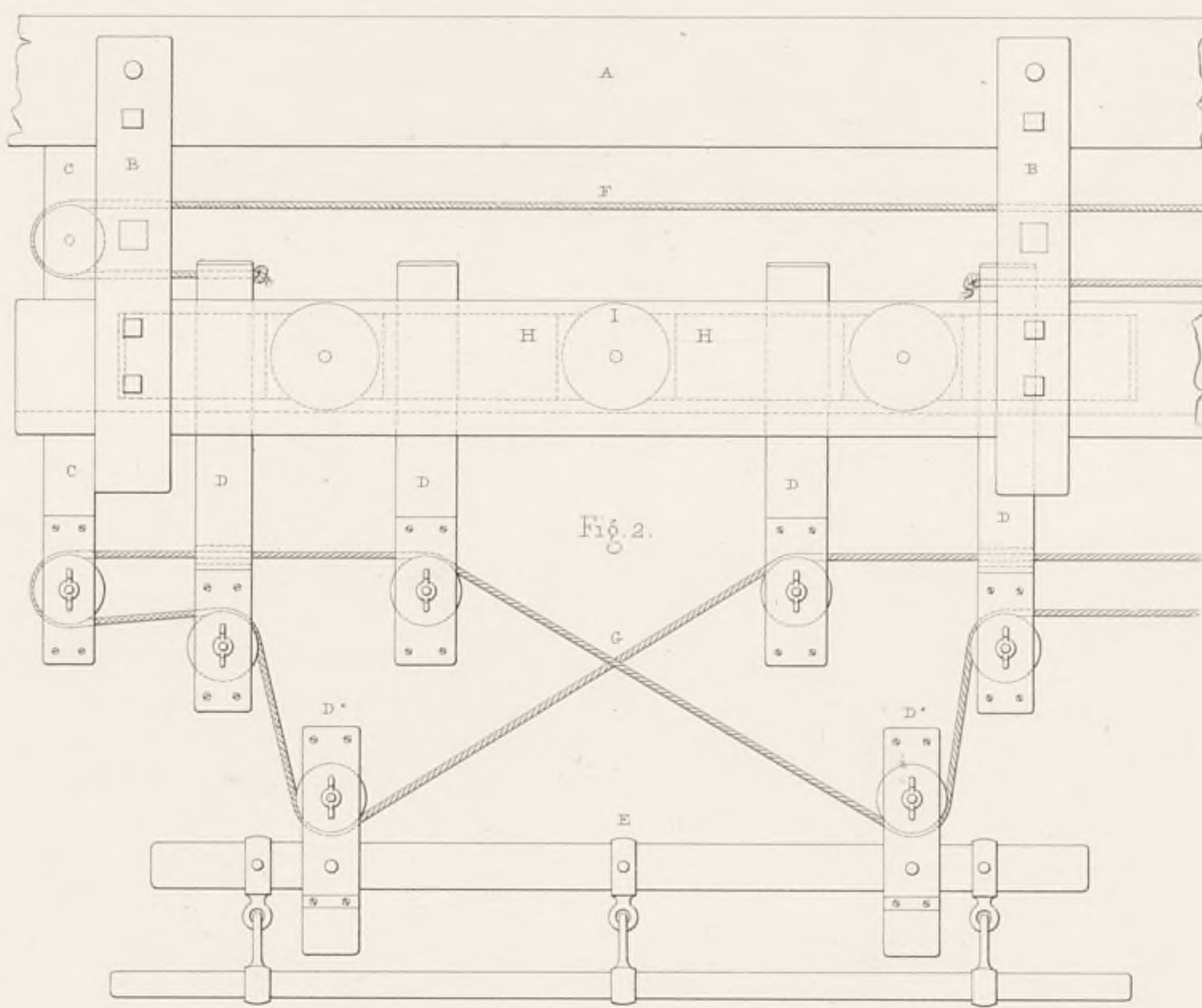
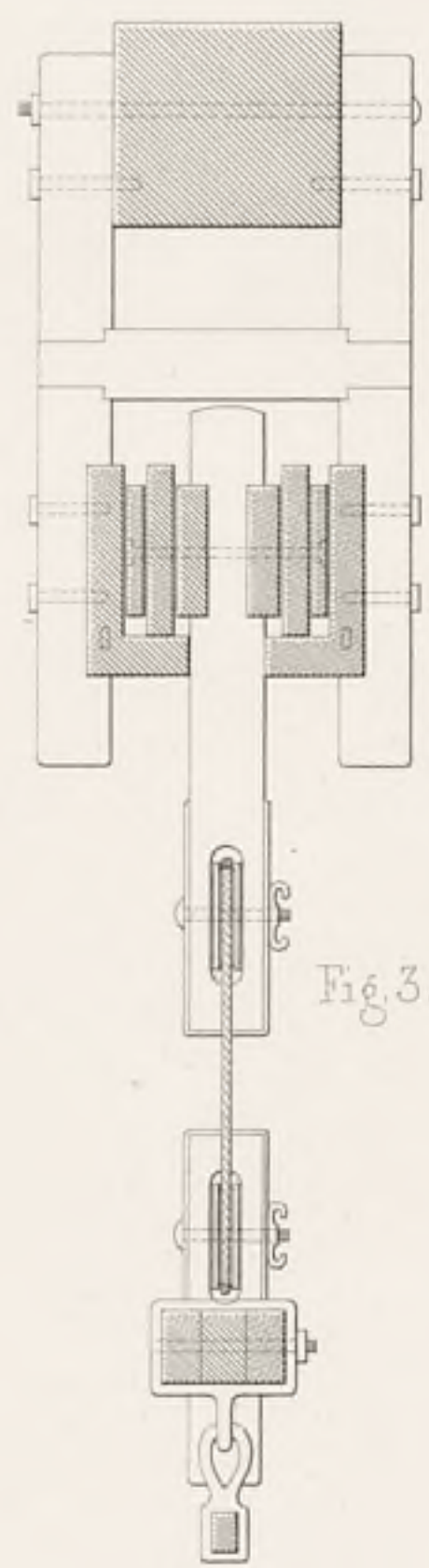
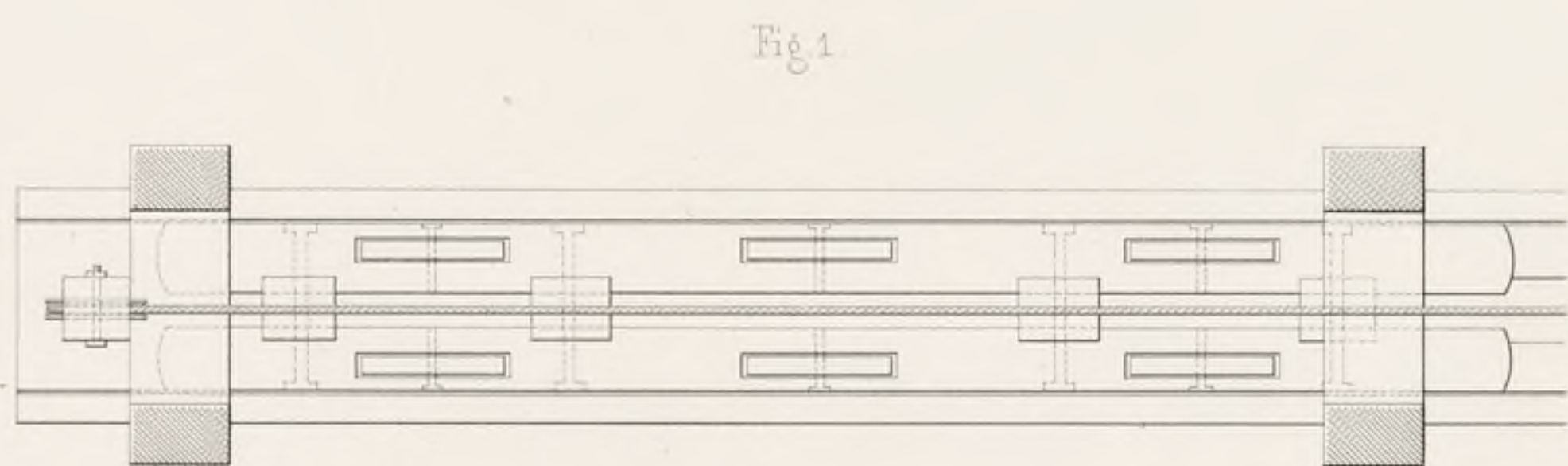
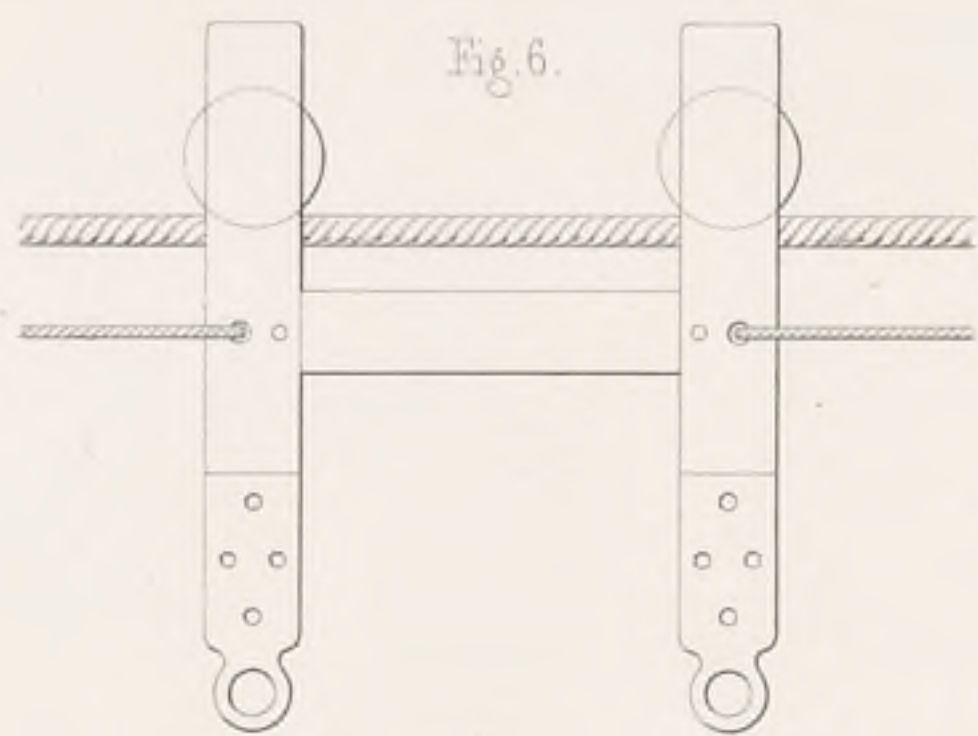
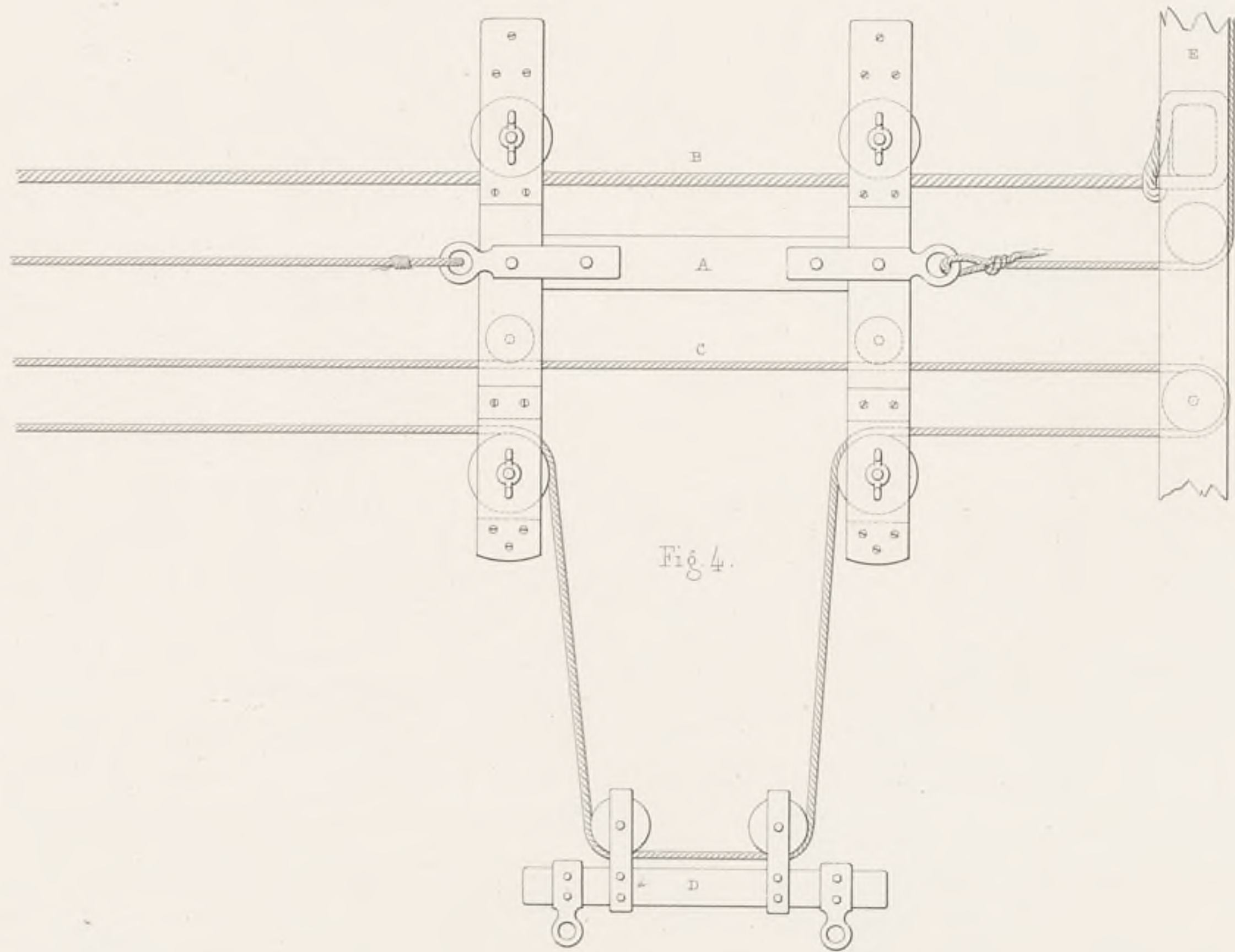

Fig. 5.



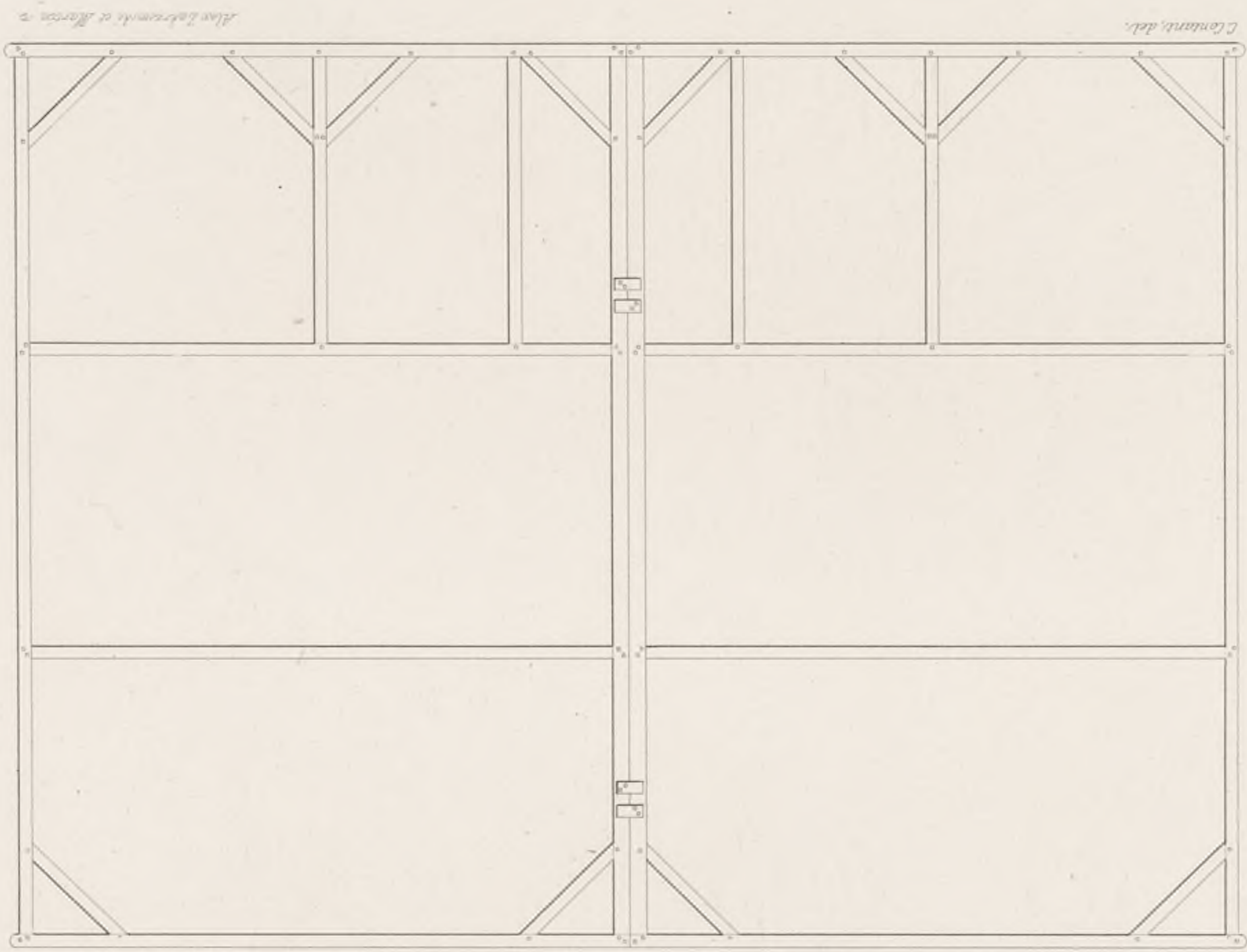

Fig. 2.



Fig. 3.

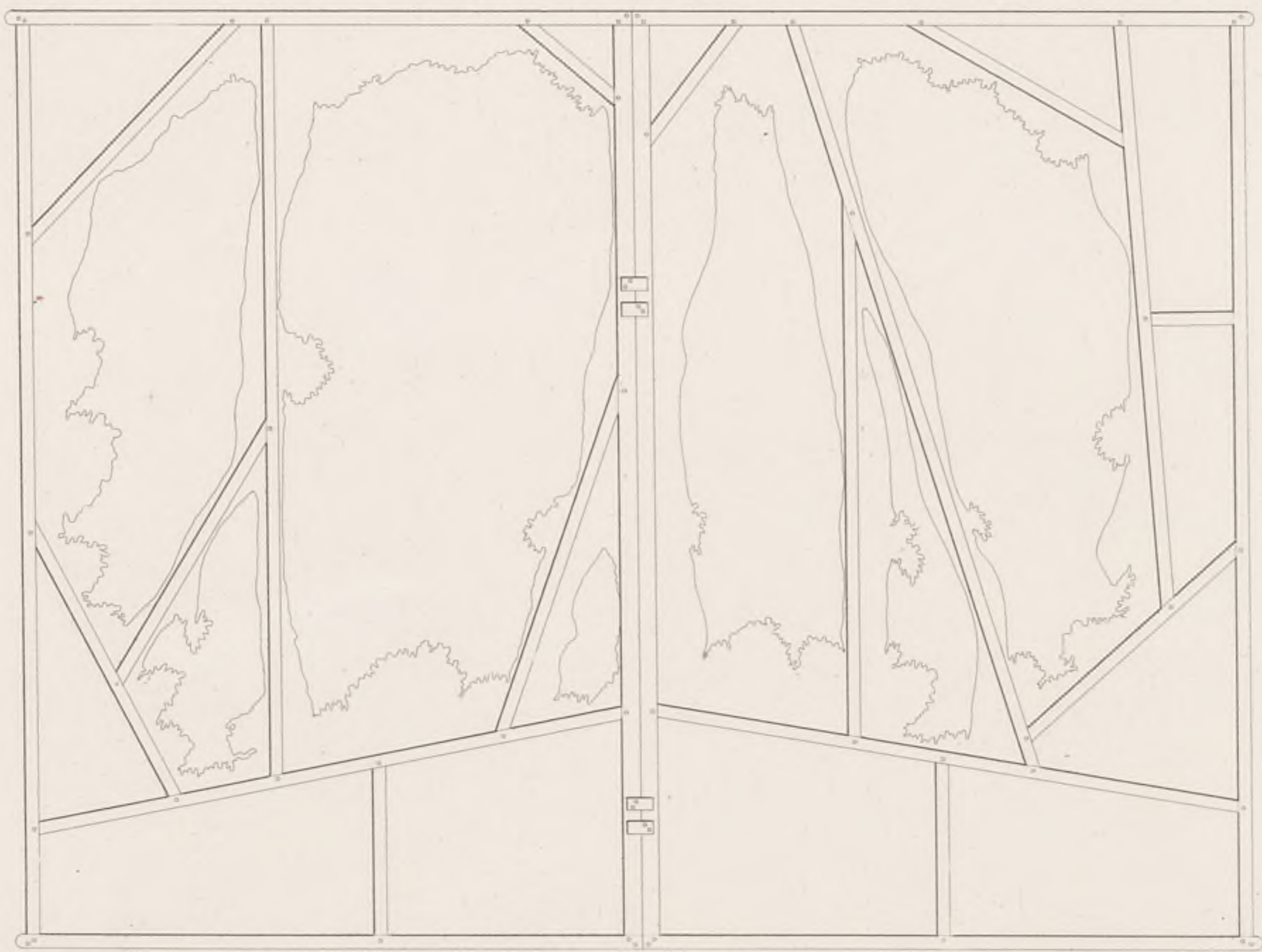
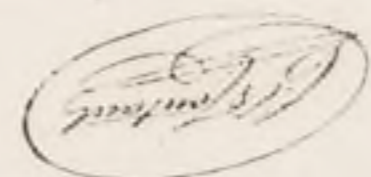

Fig. 1.
(SISTÈME ANGLAIS)

CONSTRUCTION DES FERMES.



PLAN DE LA CONSTRUCTION DES THÉÂTRES.
(SYST. ALLEMAND)

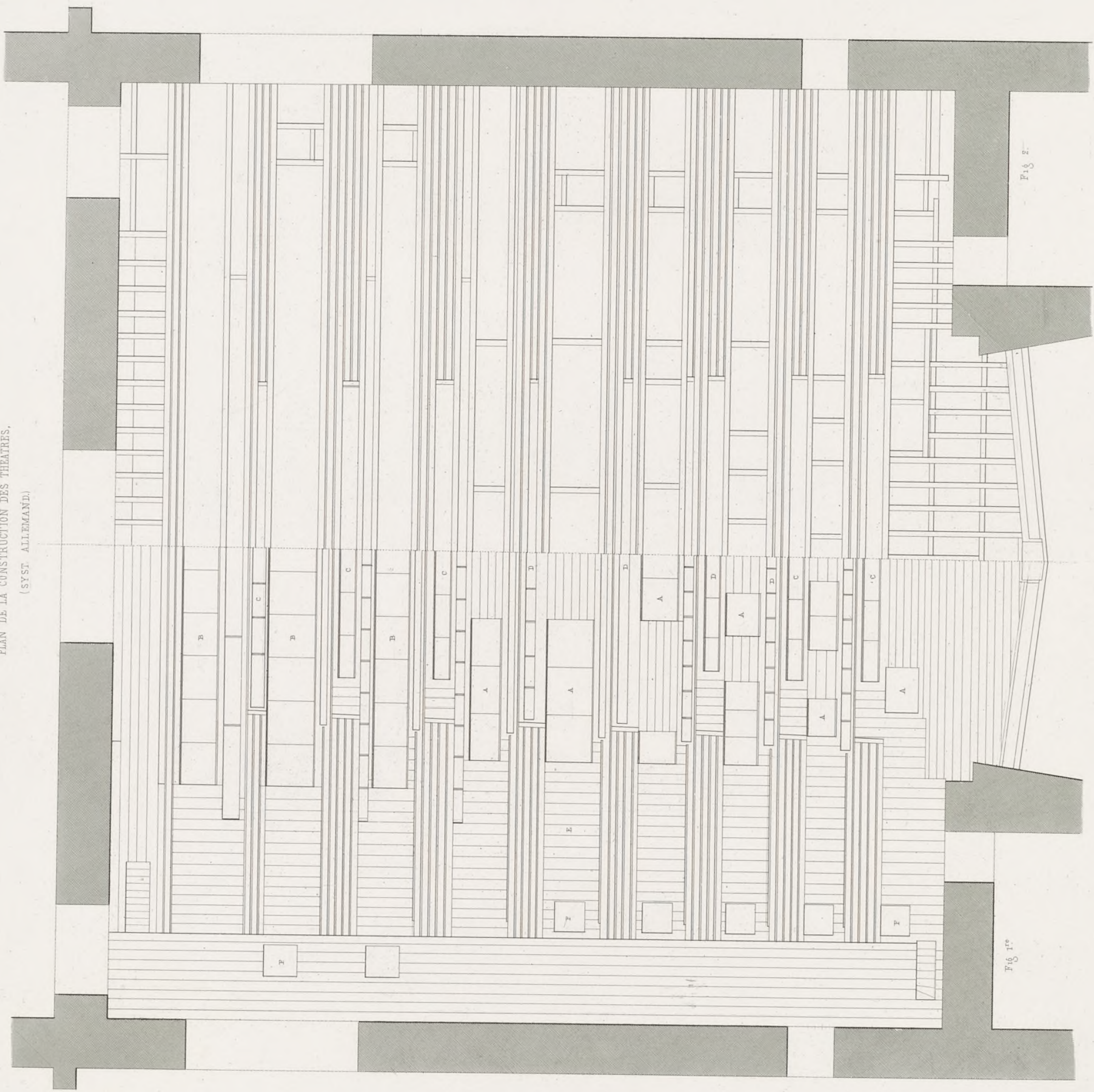

Fig. 1^{re}

Fig. 2^e



C. Coustant, d.d.

Alex. Zerkowski et Martin sc.



Constant

COUPE TRANSVERSALE DE LA CONSTRUCTION DES THEATRES.
(SYSTEME ALLEMAND.)

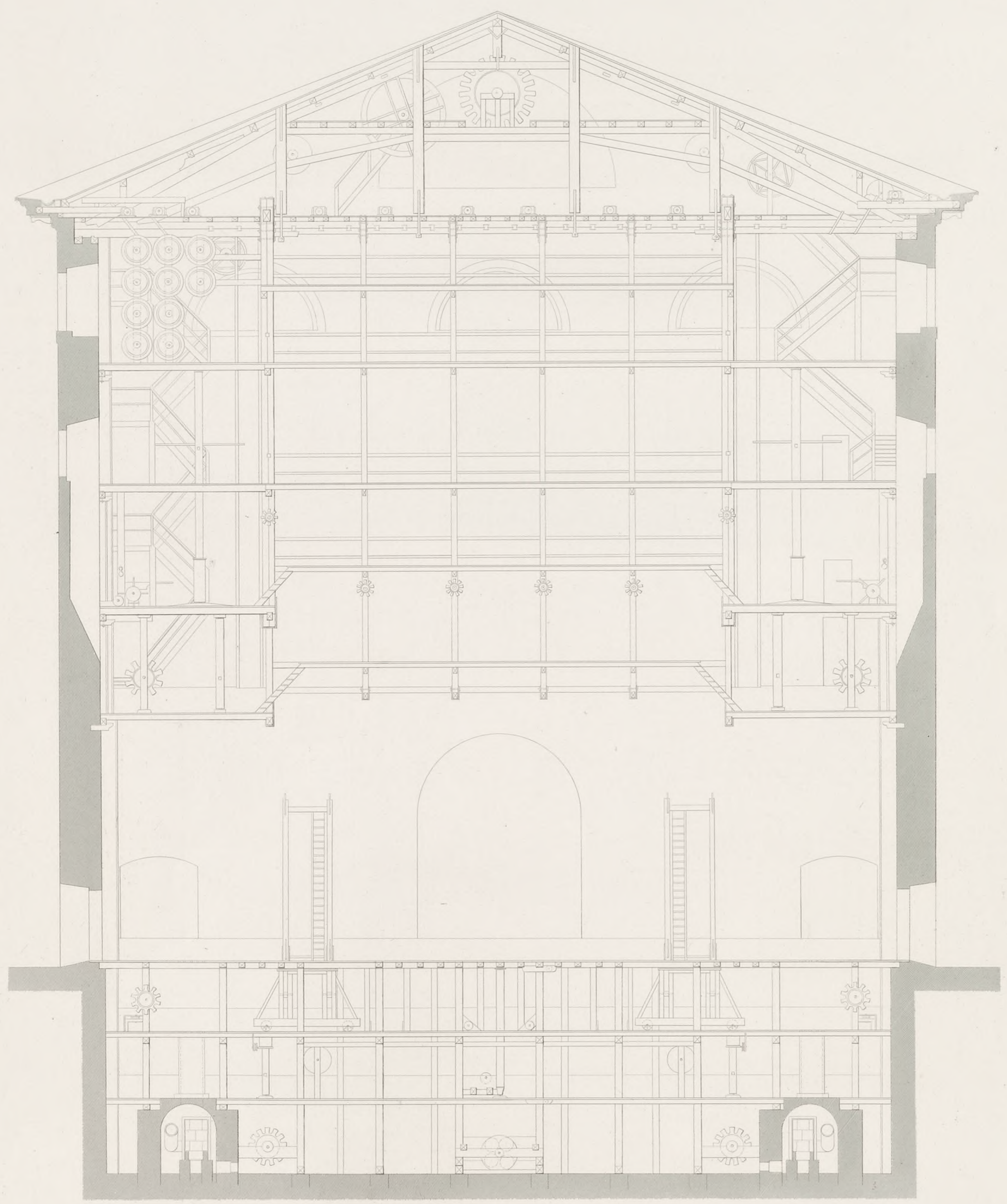

Mètres 1 2 3 4 5 6 7 8 9 10 11 12 13 14 15 16 17 18 19 20 21 22 23 24 25 26 27 28 29 30

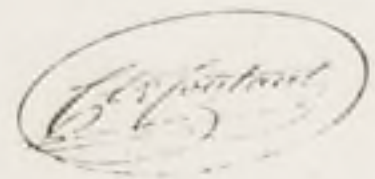

COUPE LONGITUDINALE DE LA CONSTRUCTION DES THÉÂTRES.
(SYSTÈME ALLEMAND.)

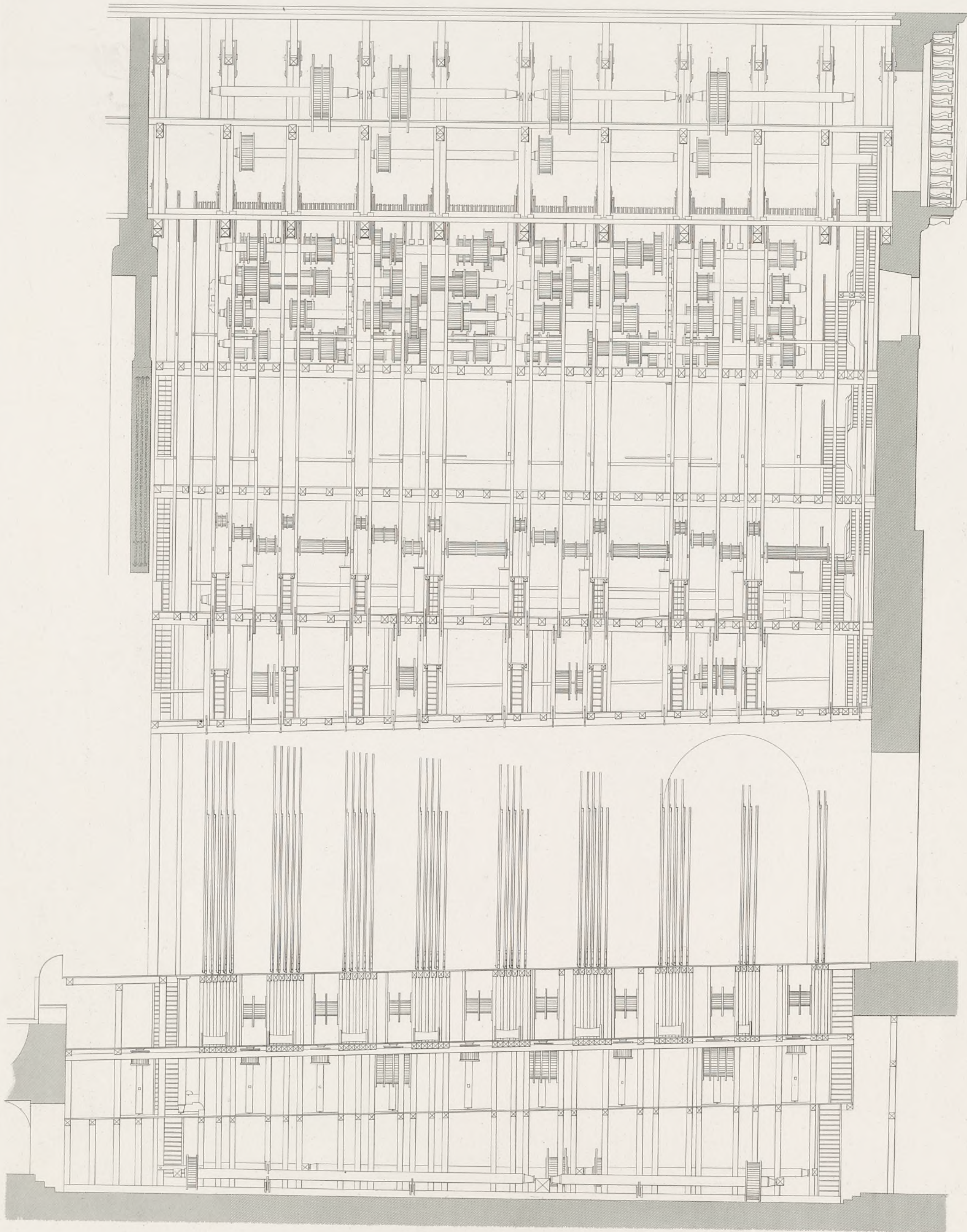

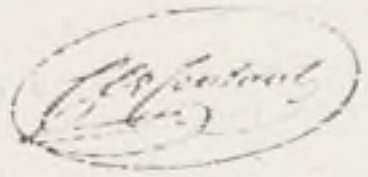

COUPE TRANSVERSALE
DES EQUIPES VOIS, CHANGEMENT, TRAPPES, RIDEAUX ET PLAFONDS.
(SYSTEME ALLEMAND)

PL. 4.

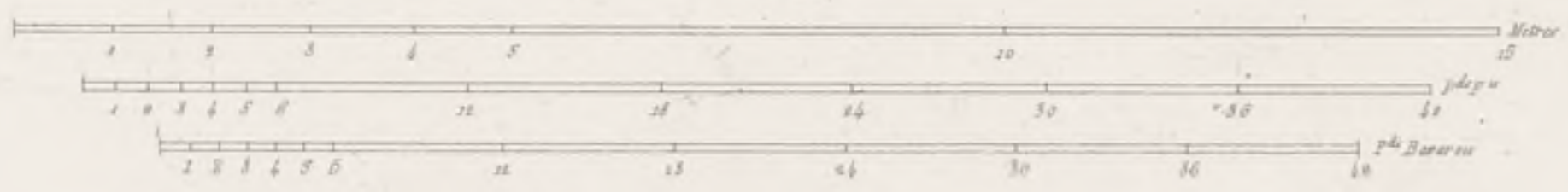
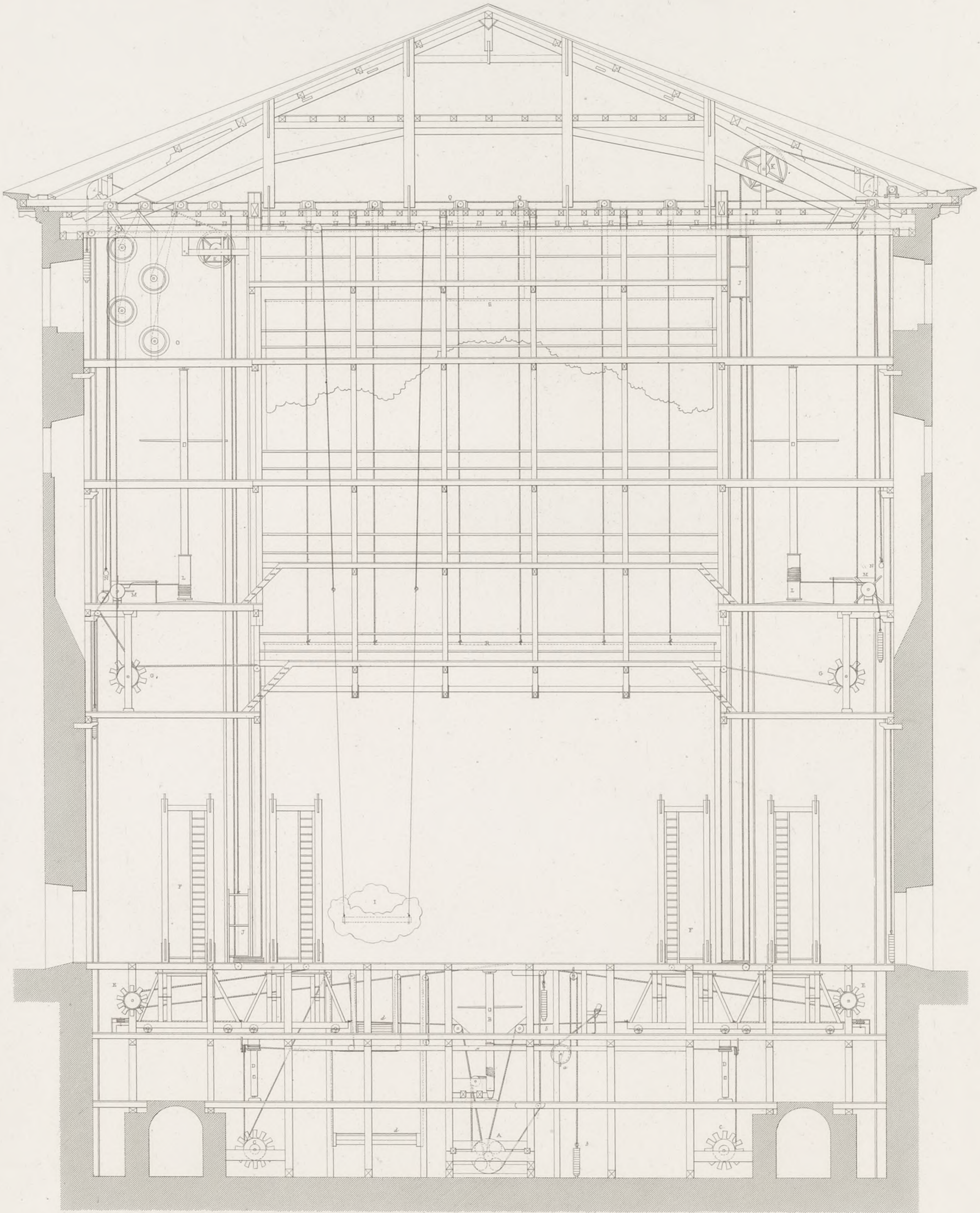

Contant del.

Alex. Zaksewski ar.

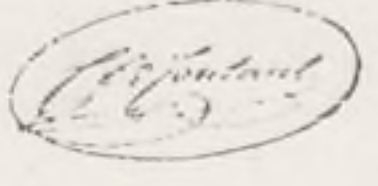

COUPE LONGITUDINALE DES EQUIPES DE VOLS, CHANGEMENT, TRAPPES, RIDEAUX ET PLAFONDS
(Syst. allemand)

